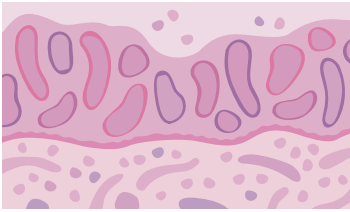
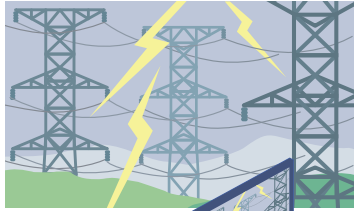

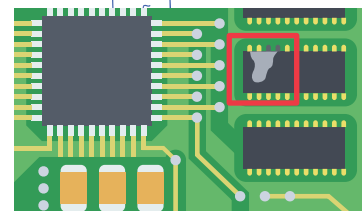
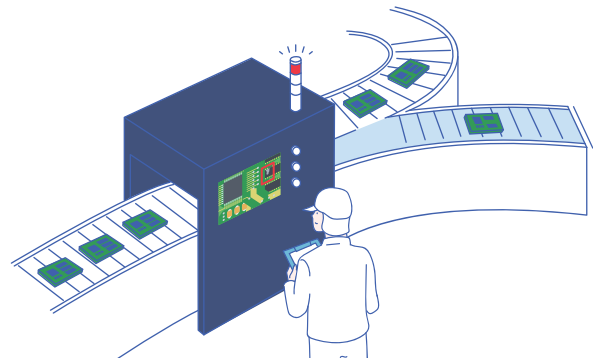

Image Optimization Systems

DuraVision[®] EVS1VX / EVS1VS



Create a Visual Advantage



Do These Situations Sound Familiar?



Situation

01

Bad weather conditions make it **difficult to recognize objects** in outdoor security footage



Situation

02

Defect detection rate hasn't improved, even with **machine vision inspection**

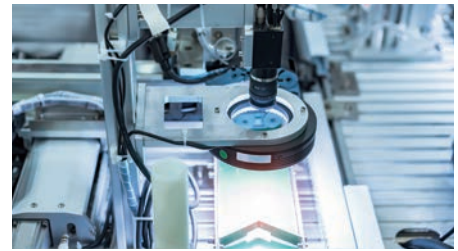

Situation

03

No issues detected during **routine image inspection**, but **problems still occur** during operation



Situation

04

Human error is an issue when it comes to surveillance **monitoring effectiveness**



Create a Visual Advantage with EIZO Image Optimization Systems

Human-Centric Surveillance Systems

Facilitate Visual Inspection

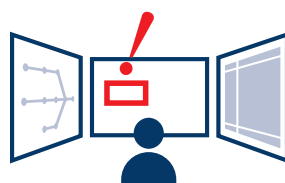

- Crime Prevention & Fault Detection
- Infrastructure Maintenance Support
- Reduced Risk of Human Error

AI-Enhanced Security Systems

Facilitate AI Video Detection

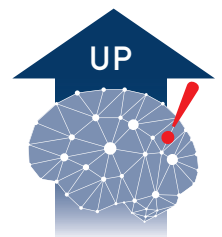

- Crime Prevention & Fault Detection
- Infrastructure Maintenance Support
- Operator Workforce Optimization

Applications

EIZO's image optimization systems enhance visibility in a diverse range of situations where close inspection of video is needed.

Real-Time Surveillance



Manufacturing & Waste Treatment

Supervise Operations



Surveillance Monitoring

Detect Suspicious Activity

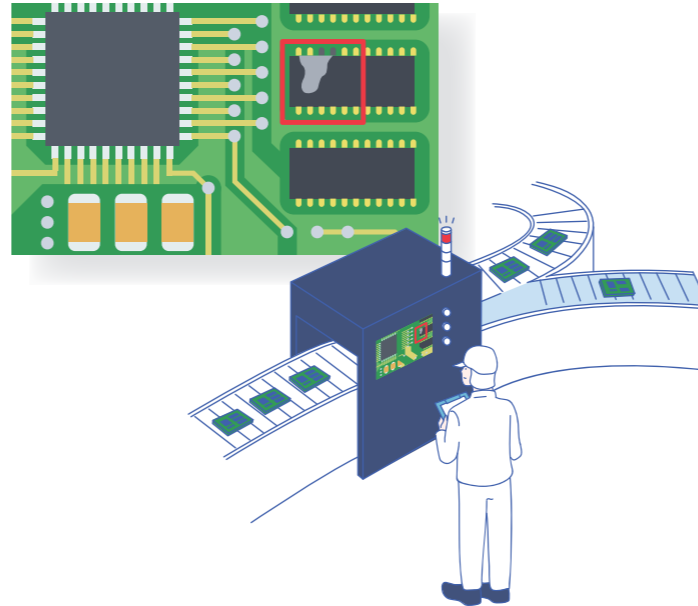

Product & Food Inspection

Identify Defects



Harbor Surveillance

Detect Suspicious Objects



Waterway Monitoring

Determine Anomalies

Infrastructure Maintenance



Railway Monitoring & Equipment Management

Safety Measures and Disaster Prevention



Highway, Pier & Tunnel Inspection

Condition Based Maintenance



Pylon, Sewer & Dam Monitoring

Early Hazard Detection



Scientific Image Analysis

Detailed Image Assessment

Image Analysis

Enhance Visibility with EIZO's Image Optimization Systems



DuraVision EVS1VX and EVS1VS image optimization systems connect to a camera, recorder, or other image output device via HDMI and process incoming video content to make it easier to see. They use EIZO's unique visibility enhancement technology to analyze and process images in real time without altering the source data.

Diverse Product Range

EIZO's extensive range of products and solutions offer a multitude of feature sets that meet the diverse requirements of visual monitoring applications.

Recommended Monitors

EIZO recommends these monitors to use with the image optimization systems.



FlexScan EV2760

27" (2560 x 1440) monitor

- 4 video inputs, including HDMI
- 4-port USB hub
- 3-sided frameless
- Space-saving features
- Eco-friendly & ergonomic features



FlexScan EV2460

23.8" (1920 x 1080) monitor

- 4 video inputs, including HDMI
- 4-port USB hub
- 3-sided frameless
- Space-saving features
- Eco-friendly & ergonomic features

Flexible Installation

The EVS1VX / EVS1VS can easily be installed on the back of EIZO monitors using the dedicated adapter.



PCSK-03 / PCSK-03R

DuraVision® EVS1VX

Enhanced Visibility in Real Time

The EVS1VX is powered by EIZO's cutting-edge Visibility Optimizer X technology which analyzes and adjusts images pixel-by-pixel in real time. Visibility Optimizer X features advanced image processing and fine-tune control over image enhancement for environments with specialized needs.

Feature 01 Optimize Hard-to-See Images (Combines DuraVision EVS1VS features 01+02) Patent no. 5470415, no. 6749510

The EVS1VX detects areas of the image that are difficult to see due to low lighting conditions or haze and corrects them to be more visible. It addresses both dark and light areas of the image by adjusting the brightness of each pixel, while preserving details for a realistic sense of depth. This is useful not only for surveillance at night or in foggy conditions, but also for detecting irregularities or cracks in surfaces, such as concrete.



Feature 02 Reduce High-ISO Noise Optional Feature

The EVS1VX combines both 2D and 3D noise reduction functions to improve clarity in contours and help distinguish objects in video, particularly for nighttime surveillance. 3D noise reduction uses visual information from the previous frame to assess the disparity between subsequent frames and is effective when monitoring static video. 2D noise reduction analyzes content based on a single frame and is optimal for video that captures motion or has scene changes. The EVS1VX automatically prioritizes the noise reduction method to suit the content displayed.

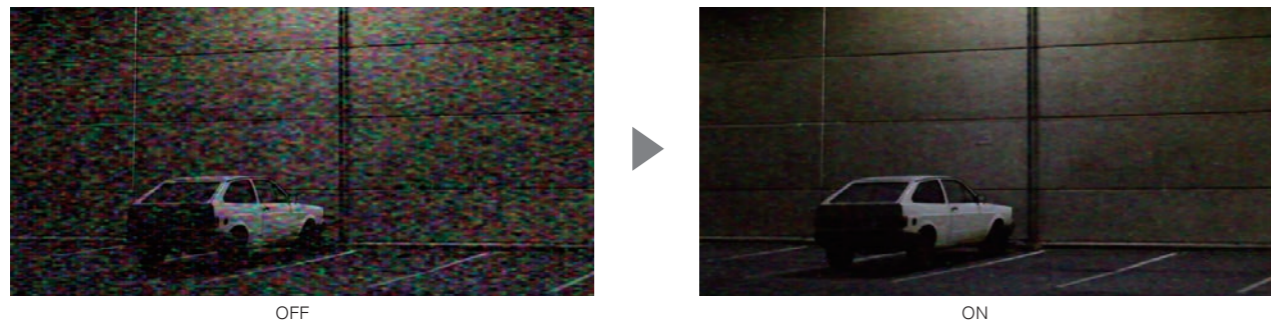

Feature 03 Distinguish Details in Color Dominated Images Optional Feature Patent no. 6749504

The EVS1VX improves visibility in images dominated by a single color. It addresses colors with little variation in brightness to make them easier to distinguish. This is particularly effective when analyzing endoscopic and pathological images, or for detecting objects in underwater images.



DuraVision® EVS1VS

Enhanced Visibility in Real Time

The EVS1VS includes EIZO's standard Visibility Optimizer technology which processes images in real time.

Feature 01 Improve Visibility in Low Lighting Conditions Patent no. 5247910, no. 5470415

The EVS1VS detects areas of the image that are difficult to see due to low lighting conditions, while ensuring the lighter areas do not become washed out. This is useful when viewing surveillance video at night or areas with little to no lighting.

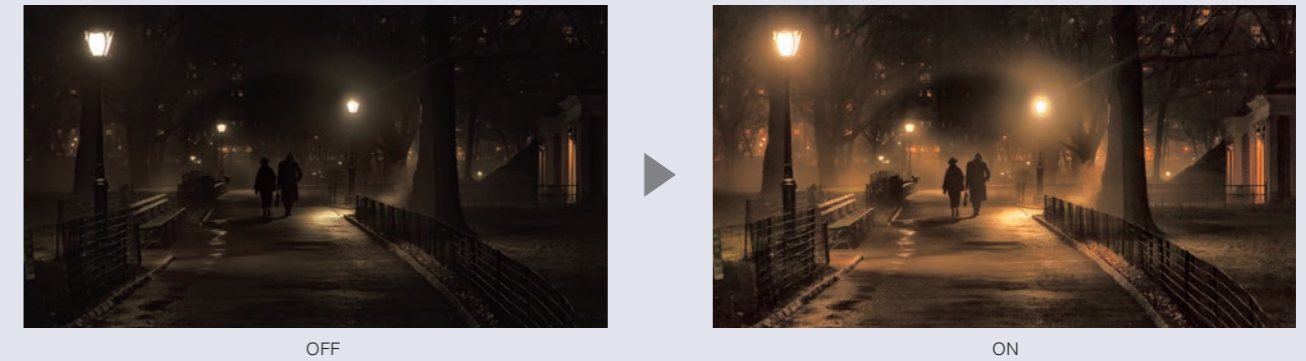

Feature 02 Reduce Visual Impact of Atmospheric Haze Patent No. 6228670

The EVS1VS detects areas of the image that appear hazy due to fog, smoke, snow, or other environmental conditions and corrects them to be more visible. This is ideal when viewing video footage in outdoor environments.

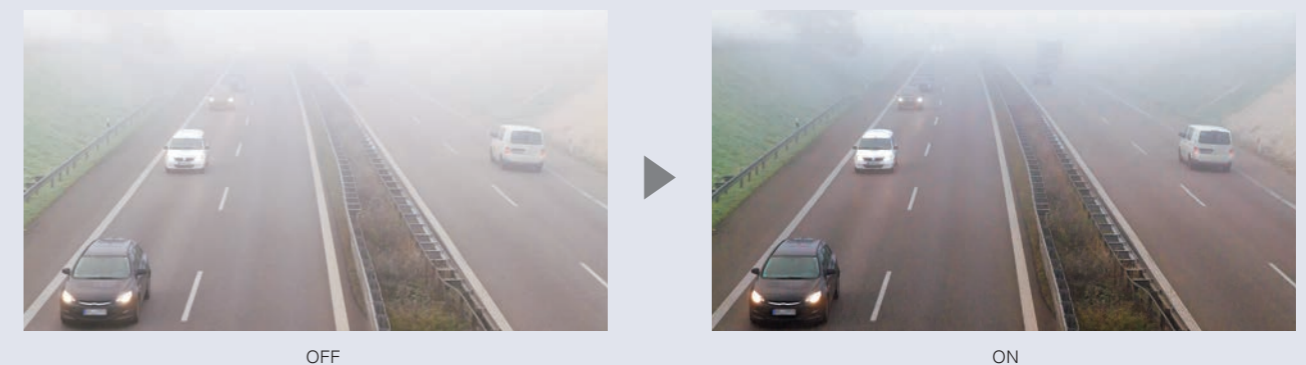

Feature 03 Reduce Block Noise Patent no. 5564553, no. 5634494

The EVS1VS uses 2D noise reduction to filter out unnatural block formations in images and make objects more distinguishable. It automatically adjusts the processing intensity to preserve natural contours and edges. This feature is effective when examining noisy, compressed images.

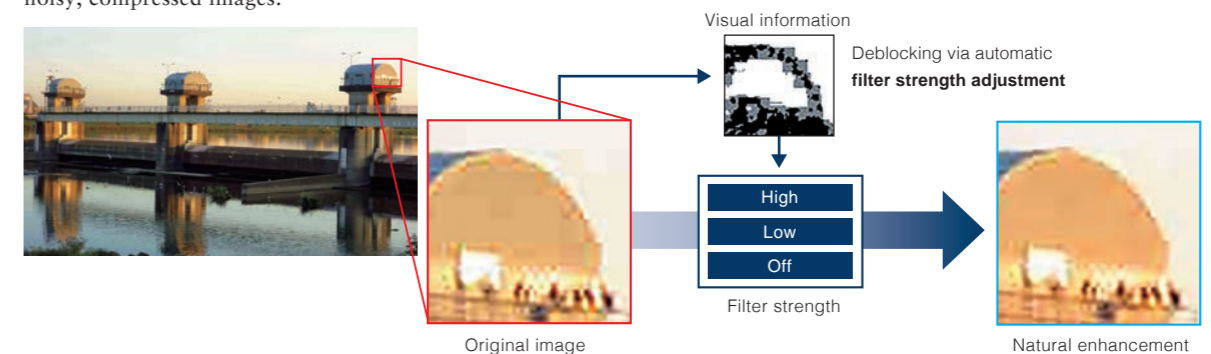

Images are for illustrative purposes. Image enhancement process is based on Retinex theory, where pixels are individually emphasized and optimized.

Choosing the Right System

			Night Surveillance		Infrastructure & Maintenance		Outdoor Surveillance	Image Recognition
Optimization Technology			Brighten dark areas	Reduce high-ISO noise	Distinguish cracks and identify defects	Reduce block noise	Improve clarity in haze or fog	Distinguish details in color dominated images
Display Modes								
EVS1VX	Visibility Optimizer X	10	Yes	Yes (optional)	Yes	Yes (optional)	Yes	Yes (optional)
EVS1VS	Visibility Optimizer	1	Yes	-	Yes	Yes	Yes	-

Additional Features

EVS Image Optimization Utility

Make fine adjustments to display modes with EIZO's proprietary EVS Image Optimization Utility and maximize footage clarity with enhanced contours, contrast, and brightness.



*-EVS Image Optimization Utility is free of charge.
-Requires connection to a PC via USB.
(cable not included)*

Local Image Enhancement EVS1VX

With the EVS Image Optimization Utility, you can custom select a specific area of the screen to apply image enhancement. This allows you to stay focused on regions of interest or limit image enhancement to only areas that require it.

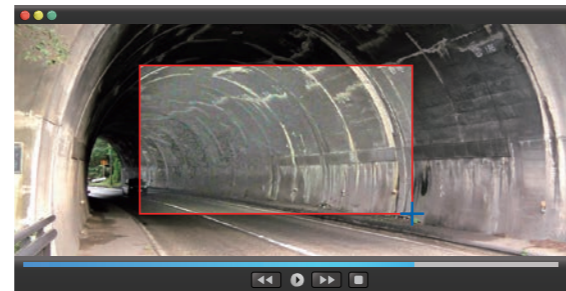

A Display Mode for Each Situation Optional Feature EVS1VX

Choose between the 4 pre-installed display modes (Standard, Balanced, High, Low) or add up to 5 custom modes which you can fine-tune to suit specific viewing environments. The EVS1VX can register up to 10 display modes which you can change between via the front buttons. You can also delist unused display modes so operators can switch to the right mode quickly.

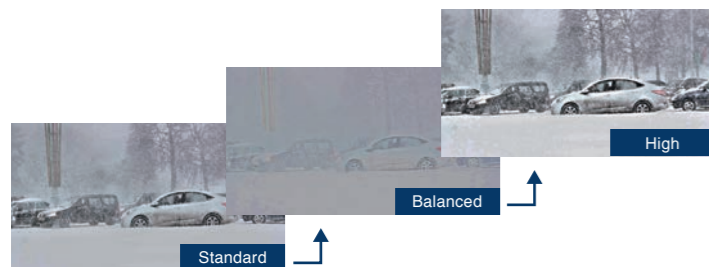

Capture Stills Directly to USB Optional Feature EVS1VX

The EVS1VX allows operators to capture stills from any enhanced scene and save them directly to a USB flash drive using a USB numeric keypad. Captured stills inherit currently set image enhancements so they can be used for secondary review or for investigative purposes.

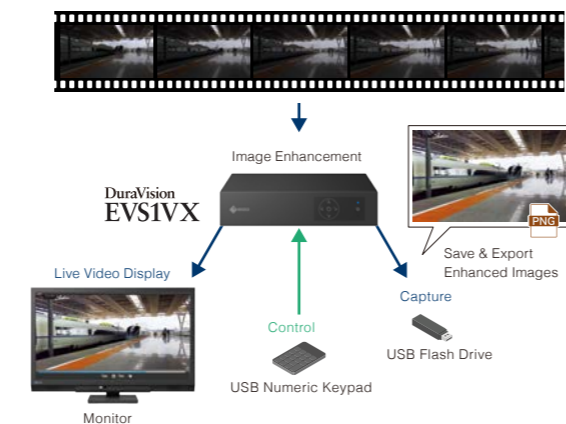

Connectivity

The EVS1VX and EVS1VS have two HDMI inputs, one HDMI output, and are equipped with an ethernet port to carry out firmware updates via the browser.

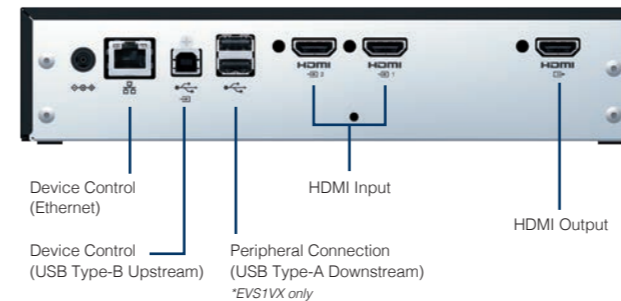

Long-Term Reliability

The EVS1VX and EVS1VS are built for 24-hour use and are backed by a 2-year manufacturer's warranty for long-term reliability.



Outline Dimensions

Dimensions (Unit: mm)

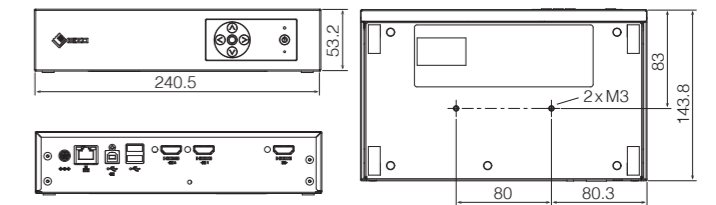

Specifications

		EVS1VX	EVS1VS
Features & Functions	Visibility Optimizer	Visibility Optimizer X	Visibility Optimizer
	Communication Interface	USB, Ethernet	USB, Ethernet
	Others	Area Selection, Preset	-
Video Signals	Input Terminals	HDMI x 2	HDMI x 2
	Output Terminals	HDMI	HDMI
	Video Formats	1080/60p, 1080/59.94p, 1080/50p, 720/60p, 720/59.94p, 720/50p	1080/60p, 1080/59.94p, 1080/50p, 720/60p, 720/59.94p, 720/50p
USB	Upstream	USB 2.0: Type-B	USB 2.0: Type-B
	Host	USB 2.0: Type-A x 2	-
Power	Power Requirements	AC 100 - 240 V, 50 / 60 Hz	AC 100 - 240 V, 50 / 60 Hz
	Maximum Power Consumption	45 W	45 W
Physical Specifications	Dimensions (W x H x D)	240.5 x 53.2 x 143.8 mm	240.5 x 53.2 x 143.8 mm
	Net Weight	1.4 kg	1.4 kg
Environmental Requirements	Operating Temperature	0 - 40°C	0 - 40°C
	Operating Humidity (R.H., non condensing)	20 - 80%	20 - 80%
Certifications & Standards (Please contact EIZO for the latest information.)		CB, CE, UKCA, cTÜVus, FCC-A, CAN ICES-3 (A), VCCI-A, RCM, RoHS, WEEE	CB, CE, UKCA, cTÜVus, FCC-A, CAN ICES-3 (A), VCCI-A, RCM, RoHS, WEEE
Supplied Accessories (May vary by country. Please contact EIZO for details.)	Signal Cables	HDMI (2 m) x 2	HDMI (2 m) x 2
	Others	AC adapter, User's manual	AC adapter, User's manual
Warranty		2 Years (24-hour use)	2 Years (24-hour use)

EIZO Corporation

153 Shimokashiwano, Hakusan, Ishikawa 924-8566 Japan

Phone +81-76-277-6792 Fax +81-76-277-6793

<https://www.eizoglobal.com>

EIZO, the EIZO Logo, and DuraVision are registered trademarks of EIZO Corporation in Japan and other countries. The terms HDMI and HDMI High-Definition Multimedia Interface, and the HDMI logo are trademarks or registered trademarks of HDMI Licensing, LLC in the United States and other countries. All other company names, product names, and logos are trademarks or registered trademarks of their respective owners. Specifications are subject to change without notice. Copyright © 2021 EIZO Corporation. All rights reserved. (210701)