



Instructions for Use

RadiForce® RX270

Color LCD Monitor

Important







**Please make sure you read the Instructions for Use and Installation Manual before use.
Please retain this manual for future reference.**

- See the Installation Manual for monitor settings and adjustments.
- The latest product information, including the Instructions for Use, is available on our web site.

www.eizoglobal.com

SAFETY SYMBOLS

This manual and this product use the safety symbols below. They denote critical information. Please read them carefully.

 WARNING	Failure to abide by the information in a WARNING may result in serious injury and can be life threatening.
 CAUTION	Failure to abide by the information in a CAUTION may result in moderate injury and/or property or product damage.
	Indicates a warning or caution. For example,  indicates an "electrical shock" hazard.
	Indicates a prohibited action. For example,  means "Do not disassemble".

This product has been adjusted specifically for use in the region to which it was originally shipped.

If operated outside this region, the product may not perform as stated in the specifications.

No part of this manual may be reproduced, stored in a retrieval system, or transmitted, in any form or by any means, electronic, mechanical, or otherwise, without the prior written permission of EIZO Corporation.

EIZO Corporation is under no obligation to hold any submitted material or information confidential unless prior arrangements are made pursuant to EIZO Corporation's receipt of said information. Although every effort has been made to ensure that this manual provides up-to-date information, please note that EIZO product specifications are subject to change without notice.

PRECAUTIONS

Important

This product has been adjusted specifically for use in the region to which it was originally shipped. If operated outside this region, the product may not perform as stated in the specifications.

To personal safety and proper maintenance, please read carefully the "PRECAUTIONS" section and the caution statements on the monitor.

Location of Caution Statement

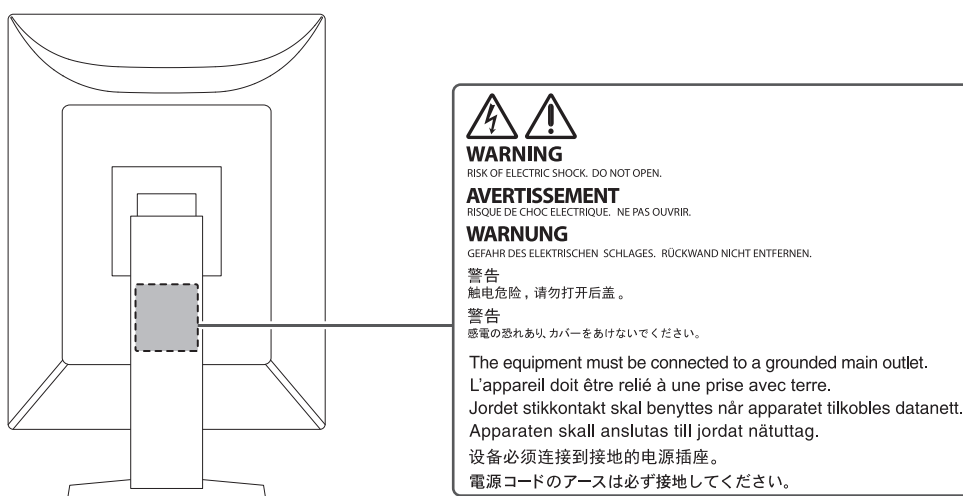

Symbols on the unit

Symbol	This symbol indicates
	Main power switch: Press to turn the monitor's main power off.
	Main power switch: Press to turn the monitor's main power on.
	Power button: Press to turn the monitor's power on or off.
	Alternating current
	Alerting electrical shock hazard
	CAUTION: See SAFETY SYMBOLS [▶ 2]
	WEEE marking: Product must be disposed of separately; materials may be recycled.
	CE marking: EU conformity mark in accordance with the provisions of Council Directive and/or Regulation (EU).
	Manufacturer
	Date of manufacture

PRECAUTIONS

Symbol	This symbol indicates
RXonly	Caution: Federal law (USA) restricts this device to sale by or on the order of a licensed healthcare practitioner.
EU Medical Device	Medical device in the EU
EU Importer	Importer in the EU
UK CA	Mark signifying compliance with UK regulations
UK Responsible Person	UK Responsible Person
CH REP	Authorised representative in Switzerland
EC REP	Authorised representative in the European Community

WARNING **WARNING**

If the unit begins to emit smoke, smells like something is burning, or makes strange noises, disconnect all power connections immediately and contact your EIZO representative for advice.

Attempting to use a malfunctioning unit may result in fire, electrical shock, or equipment damage.

 **WARNING**

Do not disassemble or modify the unit.

Opening the cabinet may result in electrical shock or burn by high-voltage or high-temperature parts. Modifying the unit may result in fire or electrical shock.

 **WARNING**

Refer all servicing to qualified service personnel.

Do not attempt to service this product yourself as opening or removing covers may result in fire, electrical shock, or equipment damage.

 **WARNING**

Keep foreign objects or liquids away from the unit.

Metal parts, flammable materials, or liquids accidentally falling into the cabinet may result in fire, electrical shock, or equipment damage.

If an object or liquid falls/spills into the cabinet, unplug the unit immediately. Have the unit checked by a qualified service engineer before using it again.

 **WARNING**

Place the unit at a sturdy and stable place.

A unit placed on an inadequate surface may fall and result in injury.

If the unit falls, disconnect the power immediately and ask your local EIZO representative for advice. Do not continue using a damaged unit. Using a damaged unit may result in fire or electrical shock.

PRECAUTIONS

WARNING

Use the unit in an appropriate location.

Otherwise, fire, electrical shock, or equipment damage may result.

- Do not place outdoors.
- Do not place in any form of transportation (ships, aircraft, trains, automobiles, etc.).
- Do not place in dusty or humid environments.
- Do not place in locations where water may be splashed on the screen (bathrooms, kitchens, etc.)
- Do not place in locations where steam comes in direct contact with the screen.
- Do not place near heat generating devices or humidifiers.
- Do not place in locations where the product is subject to direct sunlight.
- Do not place in environments with inflammable gas.
- Do not place in environments with corrosive gases (such as sulfur dioxide, hydrogen sulfide, nitrogen dioxide, chlorine, ammonia, and ozone).
- Do not place in environments with dust, components that accelerate corrosion in the atmosphere (such as sodium chloride and sulfur), conductive metals, and so on.



WARNING

Keep the plastic packing bags away from babies and children.

The plastic packing bags may cause suffocation.

WARNING

Use the enclosed power cord and connect to the standard power outlet in your country.

Be sure to use within the rated voltage of the power cord. Otherwise, fire or electric shock may result.

Power supply: 100-240 Vac 50/60 Hz

WARNING

To disconnect the power cord, grasp the plug firmly and pull.

Tugging on the cord may damage and result in fire or electrical shock.













WARNING

The equipment must be connected to a grounded main outlet.

Failure to do so may result in fire or electric shock.



 WARNING
<p>Use the correct voltage.</p> <ul style="list-style-type: none"> The unit is designed for use with a specific voltage only. Connection to another voltage than specified in this "Instructions for Use" may cause fire, electric shock, or equipment damage. Power supply: 100-240 Vac 50/60 Hz Do not overload your power circuit, as this may result in fire or electric shock.
 WARNING
<p>Handle the power cord with care.</p> <p>Do not place heavy objects on the power cord, or pull or tie the power cord. Using a damaged power cord may result in fire or electrical shock.</p> 
 WARNING
<p>The operator should not touch the patient while touching the product.</p> <p>This product has not been designed to be touched by patients.</p> 
 WARNING
<p>Never touch the plug and power cord if it begins to thunder.</p> <p>Touching them may result in electrical shock.</p> 
 WARNING
<p>When attaching an arm stand, please refer to the User's Manual of the arm stand and install the unit securely.</p> <p>Otherwise, the unit may become detached, resulting in injury and/or equipment damage.</p> <p>Before installation, make sure that desks, walls, or any other installation surface has adequate mechanical strength.</p> <p>If the unit falls, disconnect the power immediately and ask your local EIZO representative for advice. Do not continue using a damaged unit. Using a damaged unit may result in fire or electrical shock.</p> <p>When reattaching the tilt stand, please use the same screws and tighten them securely.</p>
 WARNING
<p>Do not touch a damaged LCD panel directly with bare hands.</p> <p>If any part of your skin comes in direct contact with the panel, wash thoroughly.</p> <p>If liquid crystal enters your eyes or mouth, immediately flush with large amounts of water and seek medical attention. Otherwise, you may have a toxic reaction.</p> 
 WARNING
<p>For installment in high locations, ask for the help of a professional.</p> <p>When installing the monitor in a high location, there is a risk of the product or its parts falling and causing injury. Ask for help from us or from a professional who specializes in construction work when installing the monitor, including an inspection of the product for any damage or deformities both before and after installing the monitor.</p>

CAUTION

CAUTION

Check the operational state before use.

Begin use after ensuring that there are no problems with the displayed image.

When using multiple units, begin use after ensuring that the images are displayed appropriately.

CAUTION

Securely fix cables / cords that have a fixing feature.

If they are not fixed securely, cables / cords may disconnect, and subsequently images may be cut off and your operations may be disrupted.

CAUTION

Disconnect cables and remove accessories when moving the unit.

Otherwise, the cables or accessories may become detached when moving, resulting in injury.

CAUTION

Carry or place the unit according to the correct specified methods.

- When moving the product, hold the bottom of the monitor firmly.
- Monitors of size 30 inches and above are heavy. When unpacking and/or carrying the monitor, ensure at least two people are utilized.
- If your device model has a handle on the back of the monitor, grasp and firmly hold the bottom and handle of the monitor.

Dropping the unit may result in injury or equipment damage.

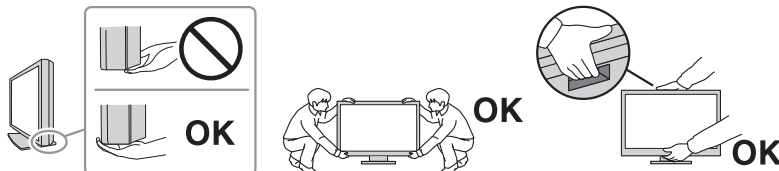

CAUTION

Exercise care not to pinch your hands.











If you suddenly apply force to the monitor to adjust its height or angle, your hands may be pinched and injured.

CAUTION

Do not block the ventilation slots on the cabinet.

- Do not place any objects on the ventilation slots.
- Do not install the unit in a place with poor ventilation or inadequate space.
- Do not use the unit laid down or upside down.

Blocking the ventilation slots prevents proper airflow and may result in fire, electrical shock, or equipment damage.

<p> CAUTION</p>
<p>Do not touch the power plug with wet hands. Touching them may result in electrical shock.</p>  
<p> CAUTION</p>
<p>Do not place any objects around the power plug. This is to facilitate disconnecting the power plug in case of a problem to avoid fire or electrical shock.</p> 
<p> CAUTION</p>
<p>Periodically clean the area around the power plug and the ventilation slot of the monitor. Dust, water, or oil adhered to this area may result in fire.</p>
<p> CAUTION</p>
<p>Unplug the unit before cleaning it. Cleaning the unit while it is plugged into a power outlet may result in electrical shock.</p>
<p> CAUTION</p>
<p>If you plan to leave the unit unused for an extended period of time, disconnect the power plug from the wall socket after turning off the power switch for the safety and the power saving.</p>
<p> CAUTION</p>
<p>Dispose of this product in accordance with the laws of the locality or country of residence.</p>
<p> CAUTION</p>
<p>For users in the territory of the EEA and Switzerland: Any serious incident that has occurred in relation to the device should be reported to the Manufacturer and the Competent Authority of the Member State in which the user and/or patient is established.</p>

Notice for this monitor

Indications for Use

This Product is indicated for use in displaying radiological images for review, analysis, and diagnosis by trained medical practitioners. The display is not intended for mammography.

Attention
<ul style="list-style-type: none">• This product may not be covered by warranty for uses other than those described in this manual.• The specifications noted in this manual are only applicable when using the power cords provided together with the product and EIZO-specified signal cables.• Only use EIZO accessories products specified by EIZO with this product.

Precautions for Use

- Parts (such as the LCD panel and the fan) may deteriorate if used over extended periods of time. Periodically check that they are operating normally.
- When the screen image is changed after displaying the same image for extended periods of time, an afterimage may remain. Use the screensaver or power save function to avoid displaying the same image for extended periods of time. An afterimage may appear even after a short time period has elapsed depending on the displayed image. To remove such a phenomenon, change the image or keep the power turned off for several hours.
- It takes about several minutes for the monitor display to stabilize. Before using the monitor, wait a few minutes or longer after the monitor power has been turned on or after the monitor has recovered from the power saving mode.
- If the monitor displays continuously over a long period of time, smudges or burn-in may appear. To maximize the life of the monitor, we recommend the monitor be turned off periodically.
- The backlight of the LCD panel has a fixed lifetime. Depending on the usage pattern, such as usage for long continuous periods, the lifespan of the backlight may run out sooner, requiring replacement. When the screen becomes dark or begins to flicker, please contact your local EIZO representative.
- The screen may have defective pixels or a small number of light dots on the screen. This is due to the characteristics of the LCD panel itself, and is not a malfunction of the product.
- Do not press on the LCD panel surface or edge of the frame strongly, as this may result in display malfunctions, such as moiré patterns, etc. If pressure is continuously applied to the LCD panel surface, the liquid crystal may deteriorate or the LCD panel may be damaged. (If the pressure marks remain on the LCD panel, leave the monitor with a black or white screen. The symptom may disappear.)
- Do not scratch or press on the LCD panel with any sharp objects, at this may result in damage to the LCD panel. Do not attempt to brush with tissues as this may scratch the panel.
- Do not touch the built-in calibration sensor (Integrated Front Sensor). Doing so may reduce the measurement accuracy or result in equipment damage.
- Depending on the environment, the value measured by the built-in illuminance sensor may differ from the value shown on a stand-alone illuminometer.
- Dew condensation may form on the surface or interior of this product when it is brought into a cold room, when the temperature suddenly rises, or when it is moved from a cold

room to a warm room. In that case, do not turn the product on. Instead wait until the dew condensation disappears, otherwise it may cause some damage to the product.

To Use the Monitor for a Long Time

Quality control

- The display quality of monitors is affected by the quality level of input signals and the degradation of the product. Perform visual checks and periodic constancy tests (including grayscale check) to comply with medical standards / guidelines according to your application, and carry out calibration as necessary. Use of the RadiCS monitor quality control software enables you to perform high-level quality control that meets medical standards / guidelines.
- It takes about 15 minutes (under our measurement conditions) for the monitor display to stabilize. Please wait 15 minutes or more after the monitor power has been turned on or the monitor has recovered from the power saving mode before performing various tests for quality control, calibration, or screen adjustment of the monitor.
- We recommend that monitors be set to the recommended level or lower to reduce changes in luminosity caused by long-term use and maintain stable brightness.
- To adjust measurement results of the integrated calibration sensor (Integrated Front Sensor) to those of an EIZO external sensor (UX2 sensor) that is sold separately, perform correlation between the Integrated Front Sensor and the external sensor using RadiCS / RadiCS LE. Periodical correlation allows you to maintain the measurement result of the Integrated Front Sensor at a level equivalent to that of the external sensor.

Attention

- The display status of the monitor may change unexpectedly due to an operating error or unexpected setting change. Using the monitor with the operation switches locked is recommended after adjusting the screen of the monitor.
For details on how to set, refer to the Installation Manual (on the CD-ROM).

Cleaning

- Periodic cleaning is recommended to keep the product looking new and to prolong its operation lifetime.
- Stains on the product can be removed by moistening part of a soft cloth with water or by using our ScreenCleaner and gently wiping.

Attention

- Do not let liquids come into direct contact with the product. If it does, wipe it off immediately.
- Do not allow liquids to get into gaps or inside the product.
- When using chemicals for cleaning or disinfection, chemicals such as alcohol and disinfectant may cause gloss variation, tarnishing, and fading of the product, and also quality deterioration of the displayed image. Do not use chemicals on a frequent basis.
- Never use a thinner, benzene, wax, or abrasive cleaner as they may damage the product.
- For more information on cleaning and disinfection, please refer to our web site.
How to check: Access www.eizoglobal.com and type "disinfect" in the site search box to search.

Disinfection with chemicals

- When disinfecting products, we recommend using chemicals which have been tested by us (see table below). Note that using these chemicals do not guarantee that the product will not be damaged or deteriorated.

Category	Chemical type	Product example
Alcohol-based	Rubbing ethanol (ethyl alcohol)	Ethanol
Alcohol-based	Isopropanol	Isopropyl alcohol (IPA)
Chlorine	Sodium hypochlorite	Purelox
Biguanide	Chlorhexidine gluconate	Hibitane solution
Alcohol-based	Benzalkonium chloride	Welpas
Aldehyde-based	Glutaral	Sterihyde
Aldehyde-based	Glutaral	Cidex Plus28

To Use the Monitor Comfortably

- An excessively dark or bright screen may affect your eyes. Adjust the brightness of the monitor according to the environmental conditions.
- Staring at the monitor for a long time tires your eyes. Take a 10-minute rest every hour.
- Look at the screen from a proper distance and from a proper angle.

Cybersecurity Warnings and Responsibilities

- Firmware update should be performed through EIZO Corporation or its distributor.
- If EIZO Corporation or its distributor instructs to update the firmware, update it immediately.

CONTENTS

PRECAUTIONS	3
Important	3
Location of Caution Statement.....	3
Symbols on the unit	3
Notice for this monitor	10
Indications for Use	10
Precautions for Use.....	10
To Use the Monitor for a Long Time	11
Quality control	11
Cleaning.....	11
Disinfection with chemicals	12
To Use the Monitor Comfortably	12
Cybersecurity Warnings and Responsibilities	12
1 Introduction	15
1.1 Features	15
1.1.1 Hybrid monochrome and color display.....	15
1.1.2 Simple wiring.....	15
1.1.3 Quality control	15
1.1.4 Equipped with USB Type-C® quick-charge function	16
1.1.5 Space-saving design.....	16
1.1.6 Monitor operation from the mouse and keyboard	16
1.2 Package Contents.....	17
1.2.1 EIZO LCD Utility Disk.....	17
1.2.2 RadiCS LE	17
1.2.3 To use RadiCS LE	18
1.3 Controls and Functions	19
1.3.1 Front.....	19
1.3.2 Back	20
2 Installation / Connection	21
2.1 Before installation.....	21
2.1.1 Installation conditions.....	21
2.2 Connecting Cables.....	22
2.3 Turning On the Power	24
2.4 Adjusting the Screen Height and Angle	25
3 No-Picture Problem	26
4 Specifications	28
4.1 List of Specifications	28
4.1.1 Type	28

CONTENTS

4.1.2	LCD Panel.....	28
4.1.3	Video Signals.....	28
4.1.4	USB.....	29
4.1.5	Power.....	29
4.1.6	Physical Specifications.....	29
4.1.7	Operating Environmental Requirements.....	29
4.1.8	Transport / Storage Conditions.....	30
4.2	Compatible Resolutions.....	30
4.3	Accessories.....	30
Appendix	31
	Medical Standard.....	31
	Classification of Equipment.....	31
	EMC Information.....	32
	Environments of Intended Use.....	32
	Technical Descriptions.....	33
	Information for Radio Interference.....	39
	For U.S.A, Canada Only.....	39

1 Introduction

Thank you very much for choosing an EIZO color LCD monitor.

1.1 Features

1.1.1 Hybrid monochrome and color display

When the Hybrid Gamma PXL function is enabled, this product automatically differentiates between monochrome and color parts of the same image at a pixel level and displays them respectively in optimal gradients.

1.1.2 Simple wiring

In addition to a DisplayPort input terminal, an output terminal is also provided.

From the output terminal (D_{OUT}), a signal can be output to a different monitor.

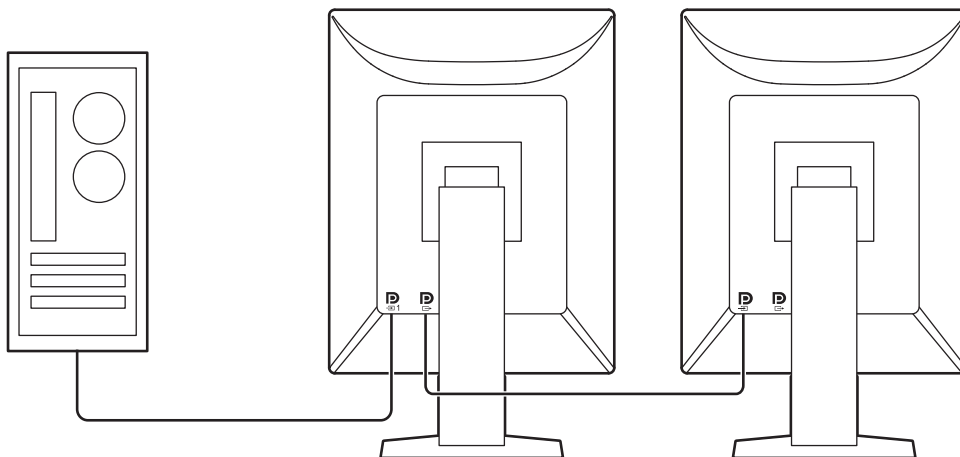

1.1.3 Quality control

- This monitor has a built-in calibration sensor (Integrated Front Sensor). This sensor enables the monitor to perform calibration (SelfCalibration) and Grayscale Check independently.

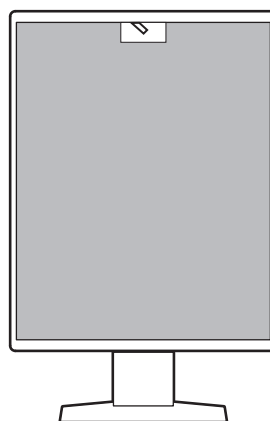

- Using the included RadiCS LE allows you to perform monitor calibration and history management.
- The RadiCS monitor quality control software enables you to perform quality control that meets medical standards / guidelines.

1.1.4 Equipped with USB Type-C® quick-charge function

This allows you to recharge your smartphone or tablet in a short period of time.

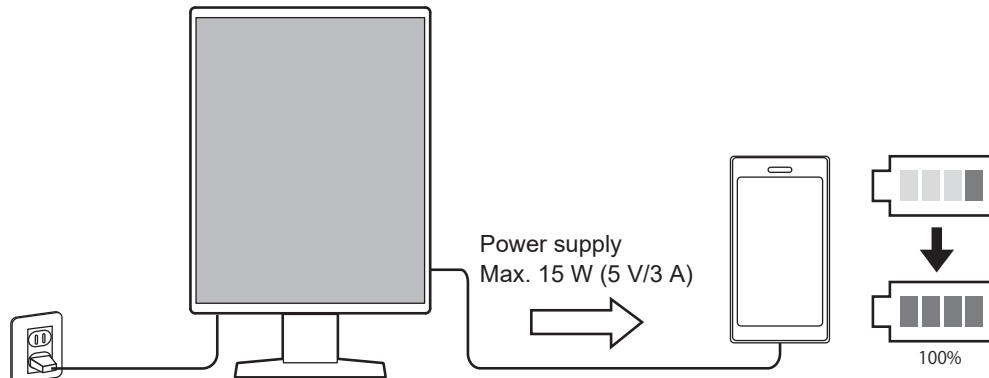

1.1.5 Space-saving design

The monitor has two USB upstream ports. You can operate two PCs using one set of USB devices (mouse, keyboard, etc.).

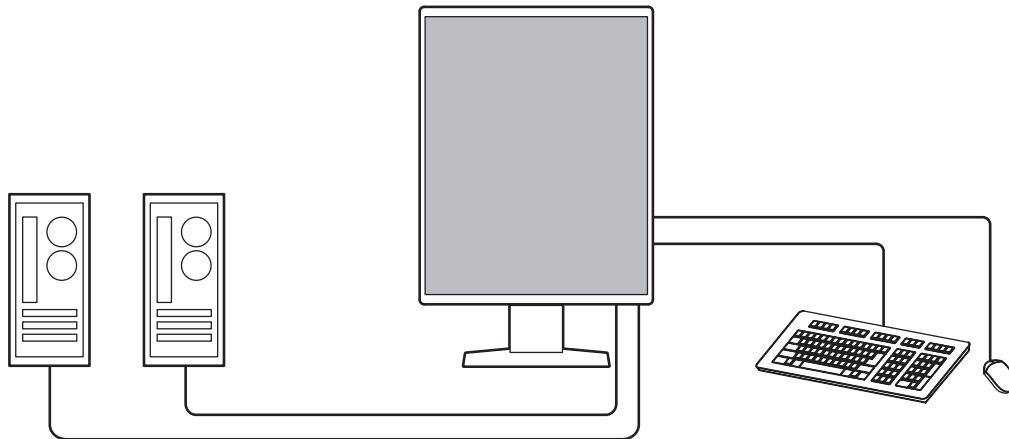

1.1.6 Monitor operation from the mouse and keyboard

Using the RadiCS / RadiCS LE monitor quality control software, you can perform the following monitor operations using the mouse and keyboard:

- Switching CAL Switch modes
- Switching input signals
- Function that assigns any CAL Switch mode to a part of the screen and displays an image (Point-and-Focus)
- Switching PCs that use USB devices (Switch-and-Go)
- Entering power saving mode (Backlight Saver)
- A feature that temporarily increases brightness to improve the visibility of diagnostic images (Instant Backlight Booster)

1.2 Package Contents

Check that all of the following items are contained in the package. If any of these are missing or damaged, contact your dealer or local EIZO representative.

Note

- It is recommended that the box and packing materials be stored so that they can be used to move or transport this product.

- Monitor
- Power cord



- Digital signal cable (DisplayPort - DisplayPort): PP300 x 2



- USB cable: UU300 x 2



- EIZO LCD Utility Disk (CD-ROM)
- Instructions for Use

1.2.1 EIZO LCD Utility Disk

The CD-ROM contains the following items. Refer to "Readme.txt" on the disk for software startup procedures or file reference procedures.

- Readme.txt file
- RadiCS LE monitor quality control software (for Windows)
- User's Manual
 - Instructions for Use of this monitor
 - Monitor Installation Manual
 - RadiCS LE User's Manual
- Outline dimensions

1.2.2 RadiCS LE

RadiCS LE enables you to perform the following quality control and monitor operations. For more information about the software or setup procedures, refer to RadiCS LE User's Manual.

Quality control

- Executing calibration
- Displaying test results in a list and creating a test report
- Setting the SelfCalibration target and execution schedule

Monitor operations

- Switching CAL Switch modes
- Switching input signals
- Function that assigns any CAL Switch mode to a part of the screen and displays an image (Point-and-Focus)
- Switching PCs that use USB devices (Switch-and-Go)
- Entering power saving mode (Backlight Saver)
- A feature that temporarily increases brightness to improve the visibility of diagnostic images (Instant Backlight Booster)
- A feature that automatically adjusts monitor brightness to match the ambient light level when set to Text mode (Auto Brightness Control)

Attention
<ul style="list-style-type: none">• The specifications of RadiCS LE are subject to change without notice. The latest version of RadiCS LE is available for download from our web site: (www.eizoglobal.com)

1.2.3 To use RadiCS LE

For information on how to install and use RadiCS LE, refer to RadiCS LE User's Manual (on the CD-ROM).

When using RadiCS LE, connect the monitor to your PC using the supplied USB cable. For more information about how to connect the monitor, see [2.2 Connecting Cables \[▶ 22\]](#).

1.3 Controls and Functions

1.3.1 Front

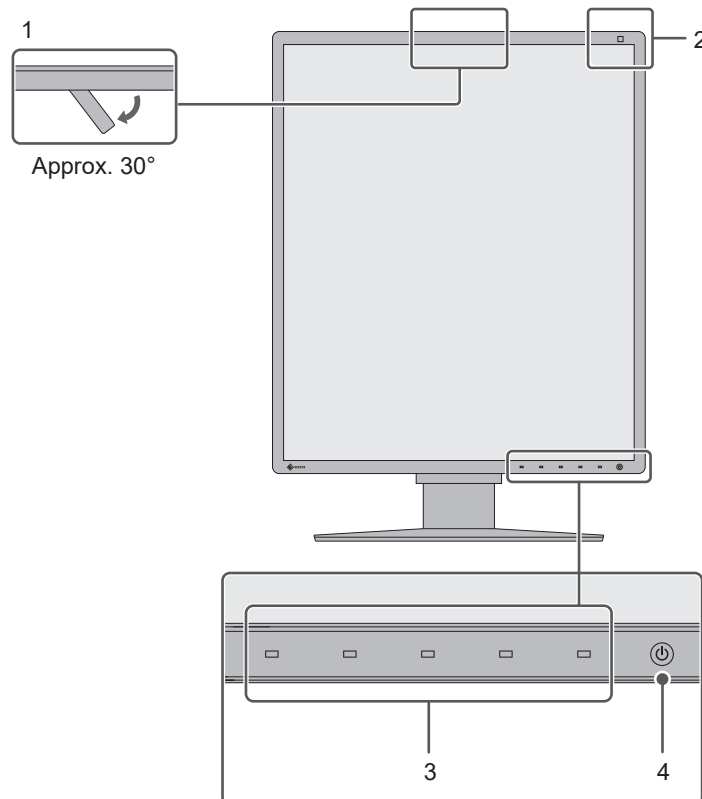

1. Integrated Front Sensor (Movable)	This sensor is used to perform calibration and Grayscale Check.
2. Illuminance Sensor	This sensor measures environmental illumination. Environmental illumination measurement is performed using the RadiCS / RadiCS LE quality control software.
3. Operation switches	Displays the operation guide. Set menus according to the operation guide.
4.  switch	Turns the power on or off. The switch indicator is lit when you turn the power on. The indicator color differs depending on the monitor's operation status. Green: Normal operation mode, Orange: Power saving mode, Off: Main power / power turned off

1.3.2 Back

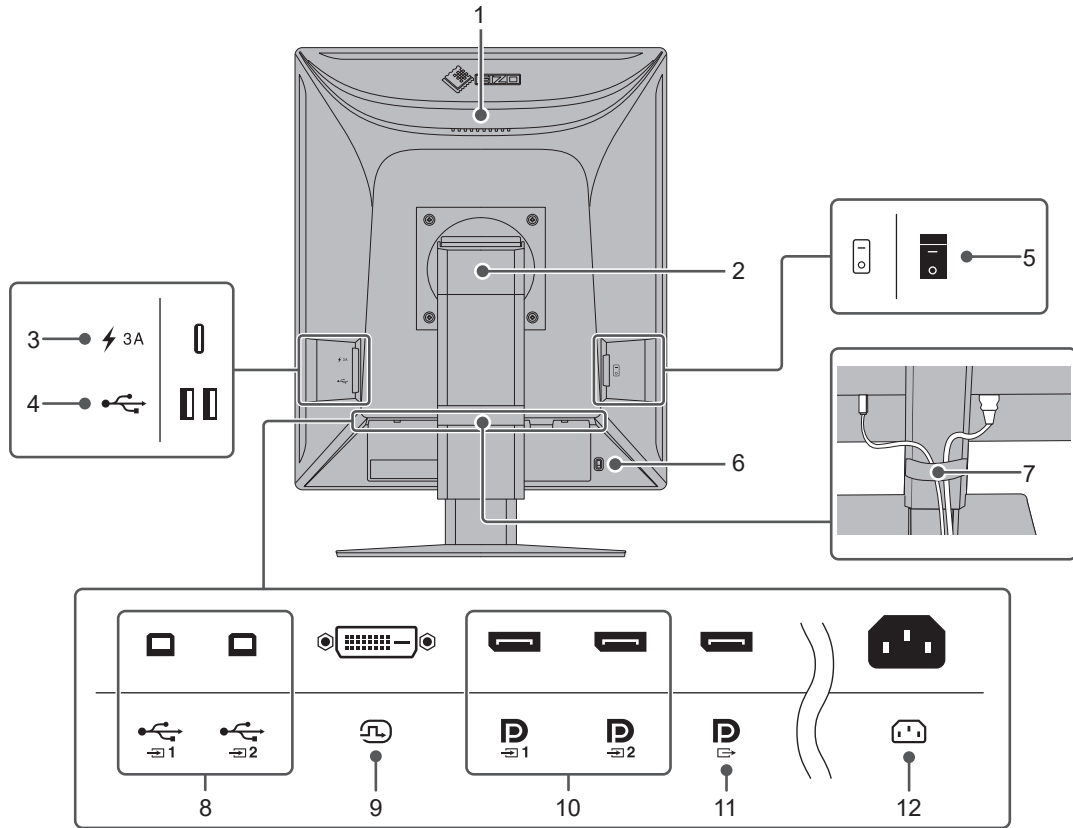

<p>1. Handle</p>	<p>This handle is used for transportation.</p> <p>Attention</p> <ul style="list-style-type: none"> Firmly hold the monitor by the handle and the bottom while carrying it, and do not put pressure on the LCD panel or drop the monitor. Do not hold the sensor section on the front side of the monitor.
<p>2. Stand</p>	<p>Adjusts the height and angle (tilt, swivel, rotation) of the monitor.</p>
<p>3. USB Type-C connector (quick charge only)</p>	<p>This allows you to connect and recharge your smartphone or tablet.</p> <p>Attention</p> <ul style="list-style-type: none"> Does not support video signals or data communication
<p>4. USB Type-A connector (USB downstream port)</p>	<p>Connect it to a USB device. To set up a daisy-chain connection, connect the cable to the USB upstream port of another monitor.</p>
<p>5. Main power switch</p>	<p>Turns the main power on or off.</p> <p>○ : Off, : On</p>
<p>6. Security lock slot</p>	<p>Complies with Kensington's MicroSaver security system.</p>
<p>7. Cable holder</p>	<p>Holds the monitor cables.</p>
<p>8. USB Type-B connector (USB upstream port)</p>	<p>Connect this port to the PC when you use software that needs a USB connection or you connect a USB device (a peripheral device that supports USB) to the USB downstream port.</p>
<p>9. DVI-D connector</p>	<p>Connect it to the PC.</p>
<p>10. DisplayPort input connector</p>	
<p>11. DisplayPort output connector</p>	<p>To set up a daisy-chain connection, connect the cable to the DisplayPort input connector of another monitor.</p>
<p>12. Power connector</p>	<p>Connects the power cord.</p>

2 Installation / Connection

2.1 Before installation

Carefully read [PRECAUTIONS \[▶ 3\]](#) and always follow the instructions.

If you place this product on a lacquer-coated desk, the color may adhere to the bottom of the stand due to the composition of the rubber. Check the desk surface before use.

2.1.1 Installation conditions

When installing the monitor in a rack, ensure that there is adequate space around the sides, back and top of the monitor.

Attention
<ul style="list-style-type: none">• Position the monitor so that there is no light to interfere with the screen.

2.2 Connecting Cables

Attention

- Check that the monitor, PC, and peripherals are powered off.
- When replacing the current monitor with this monitor, see [4.2 Compatible Resolutions \[▶ 30\]](#) to change the PC settings for resolution and vertical scan frequency to those that are available for this monitor, before connecting the PC.

1. Connect signal cables.

Check the shapes of the connectors, and connect the cables. After connecting the DVI cable, tighten the fasteners to secure the connector.

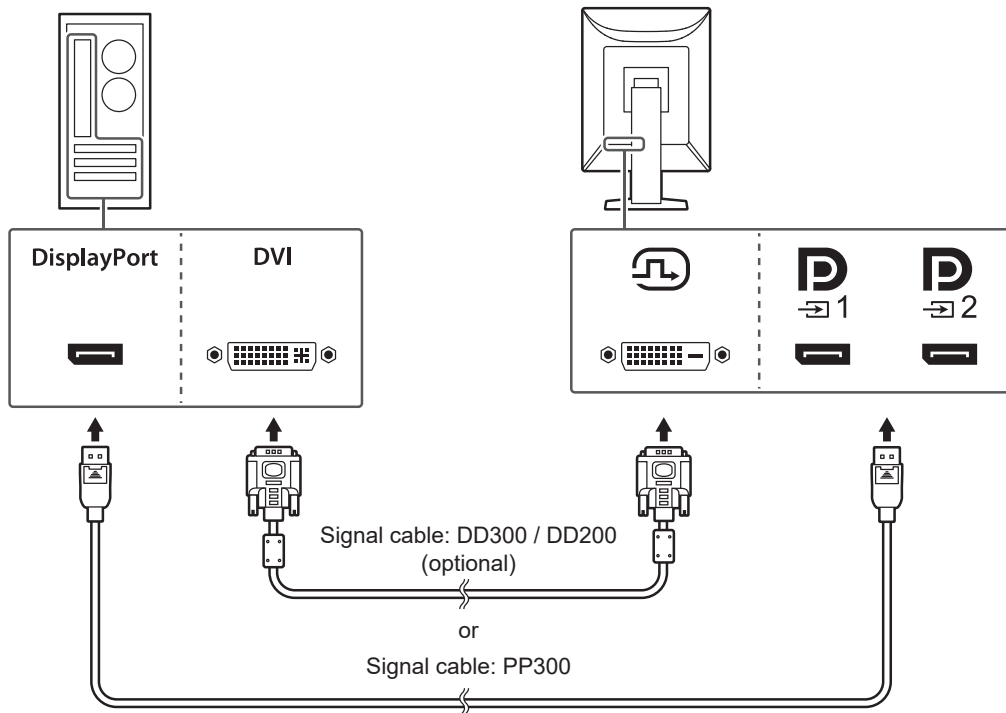

Attention

- The DisplayPort connectors of the monitor consist of input and output connectors. When connecting the monitor to a PC, connect the cable to the input connector.
- When connecting to multiple PCs, switch the input signal. For details, refer to the Installation Manual (on the CD-ROM).



Note

- If the cables are difficult to insert, adjust the angle of the screen.

When connecting other monitors using a daisy-chain connection

The signal input to is output to another monitor.

Attention

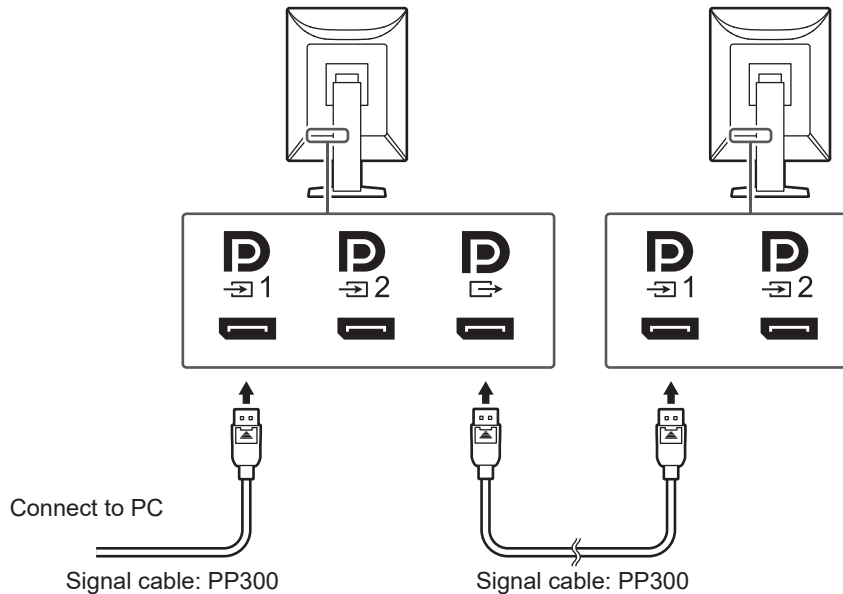

- Visit the EIZO web site for information about monitors and graphics boards that can be used for the daisy-chain connection:
(www.eizoglobal.com)
- When using a daisy-chain connection, connect the cable to the input connector .
- To set up a daisy-chain connection, you need to select "DisplayPort 1" to "Version 1.2" on the Administrator Settings menu. For details, refer to the Installation Manual (on the CD-ROM).
- Remove the  cap before connecting the signal cable.

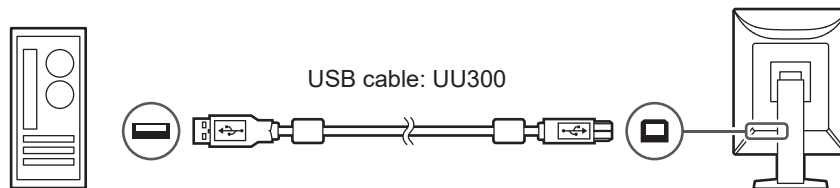

2. Plug the power cord into a power outlet and the power connector on the monitor. Insert the power cord fully into the monitor.
3. Connect the USB cable to the monitor's USB upstream port and to the PC's USB downstream port respectively.
The cable connection is required when you use RadiCS / RadiCS LE or when you connect a USB device (USB-connected peripheral device) to the monitor.



Attention



- When connecting the monitor to a PC on which RadiCS / RadiCS LE has been installed, connect the cable to .
- Remove the cap before using .

Note

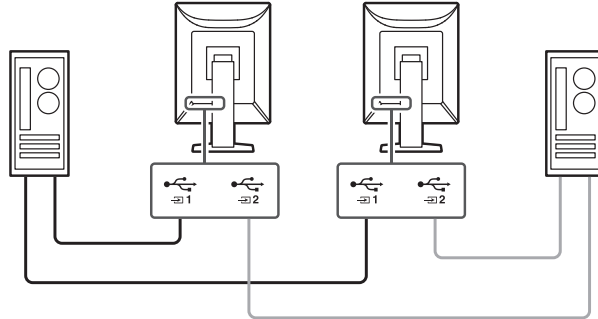

- Switching between PCs that use USB devices can be performed by connecting two PCs to two monitors as in the following figure. For details on how to switch PCs that use USB devices, refer to the Installation Manual (on the CD-ROM).



2.3 Turning On the Power

- Touch  to turn on the power to the monitor.
The power switch indicator of the monitor lights up green.
If the indicator does not light up, see [3 No-Picture Problem](#) .

Note

- When you touch any of the operation switches excluding  with the monitor power turned off,  starts flashing to let you know where the power switch is located.

- Turn on the PC.
The screen image appears.
If an image does not appear, see [3 No-Picture Problem](#)  for additional advice.

Attention

- When connecting for the first time or changing the connection method, display settings such as resolution and display scale may not be appropriate. Check if the settings for the PC are properly configured.
- For power saving purposes, it is recommended that the Power button be turned off. When not using the monitor, you can turn off the main power supply or disconnect the power plug so that the power is cut completely.

Note

- In order to maximize the monitor's lifespan by impeding brightness degradation and to reduce power consumption, carry out the following:
 - Use the power saving function of the PC or monitor.
 - Turn off the monitor after using it.

2.4 Adjusting the Screen Height and Angle

Hold the top and bottom or left and right edges of the monitor with both hands, and adjust the screen height, tilt and swivel the screen to the optimum position for performing tasks.

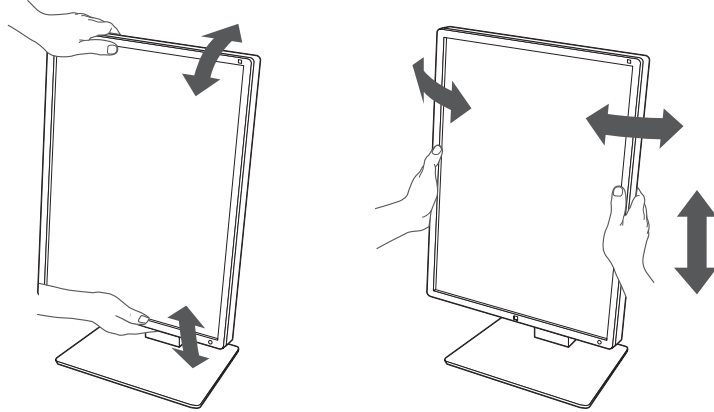

Attention

- After the adjustment is finished, make sure that the cables are correctly connected.
- After adjusting the height and angle, pass the cables through the cable holder.

3 No-Picture Problem



Power switch indicator does not light up

- Check whether the power cord is connected properly.
- Turn the main power switch on.
- Touch .
- Turn off the main power, and then turn it on again.

Power switch indicator lights up: Green

- Increase "Brightness", "Contrast", or "Gain" in the Setting menu. For details, refer to the Installation Manual (on the CD-ROM).
- Turn off the main power, and then turn it on again.

Power switch indicator lights up: Orange

- Switch the input signal. For details, refer to the Installation Manual (on the CD-ROM).
- Move the mouse or press any key on the keyboard.
- Check whether the PC is turned on.
- Check whether the signal cable is connected properly. Connect to  when selecting "DisplayPort 1", and to  when selecting "DisplayPort 2" in the input signal.  is used for output when a daisy-chain connection is set up.
- Turn off the main power, and then turn it on again.

Power switch indicator blinks: Orange, Green



- Connect via the signal cable specified by EIZO. Turn off the main power, and then turn it on again.
- If the signal cable is connected to DisplayPort 1 () , try switching the DisplayPort version. For details, refer to the Installation Manual (on the CD-ROM).

The message "No Signal" appears on the screen

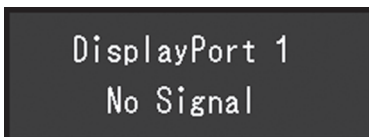
Example:



- The message shown above may appear, because some PCs do not output the signal immediately after power-on.
- Check whether the PC is turned on.
- Check whether the signal cable is connected properly. Connect the signal cables to the connectors of the corresponding input signal.
- Switch the input signal. For details, refer to the Installation Manual (on the CD-ROM).
- If the signal cable is connected to DisplayPort 1 () , try switching the DisplayPort version. For details, refer to the Installation Manual (on the CD-ROM).

- Check whether the signal cable is connected properly. Is the signal cable connected to  or  for inputting the DisplayPort signal?  is used for output when a daisy-chain connection is set up.
- Turn off the main power, and then turn it on again.

The message "Signal Error" appears on the screen

Example:

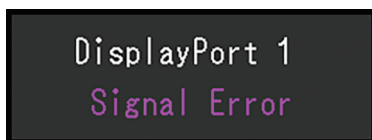

- Check whether the PC is configured to meet the resolution and vertical scan frequency requirements of the monitor (see [4.2 Compatible Resolutions \[▶ 30\]](#)).
- Reboot the PC.
- Select an appropriate setting using the graphics board's utility. Refer to the User's Manual of the graphics board for details.

4 Specifications

4.1 List of Specifications

4.1.1 Type

RX270	Anti-Glare
RX270-AR	Anti-Reflection

4.1.2 LCD Panel

Type	Color (IPS)
Backlight	LED
Size	21.3" (54.0 cm)
Resolution	1200 dots x 1600 lines
Display Size (H x V)	324.0 mm x 432.0 mm
Pixel Pitch	0.270 mm x 0.270 mm
Display Colors	10-bit color (DisplayPort): Up to 1.07 billion colors (from a palette of approx. 543 billion colors) 8-bit (DisplayPort / DVI): 16.77 million colors (from a palette of approx. 543 billion colors)
Viewing Angle (H / V, typical)	178° / 178°
Recommended Brightness	500 cd/m ²
Contrast Ratio (typical)	1800:1
Response Time (typical)	20 ms (black -> white -> black)

4.1.3 Video Signals

Input Terminals	DisplayPort x 2, DVI-D (Single Link) x 1	
Output Terminals	DisplayPort x 1	
Horizontal scan frequency	31 kHz – 100 kHz	
Vertical scan frequency ^{*1}	59 Hz – 61 Hz (720 x 400: 69 Hz – 71 Hz)	
Frame Synchronization mode	59 Hz – 61 Hz	
Dot clock	DisplayPort	25 MHz – 164.5 MHz
	DVI	25 MHz – 164.5 MHz

^{*1} The vertical scan frequency supported varies according to the resolution. For more information, see [4.2 Compatible Resolutions](#) [▶ 30].

4.1.4 USB

Port	Upstream	USB-B x 2
	Downstream	USB-A x 2
	Charging Only	USB-C® x 1 ^{*1}
Standard	USB Specification Revision 2.0	
Supply Current	Downstream (USB-A)	Max. 500 mA per port
	Quick Charge Only (USB-C) ^{*1}	Max. 15 W (5 V/3 A)

*1 For charging only. Does not support video signals or data communication

4.1.5 Power

Input	100 – 240 VAC ±10 %, 50 / 60 Hz 1.00 – 0.45 A
Maximum Power Consumption	98 W or less
Power Save Mode	1.0 W or less ^{*1}
Standby Mode	1.0 W or less ^{*2}

*1 When DisplayPort 1 input is used, the USB upstream port is not connected, "Power Save": "High", "DP Power Save": "On", "DisplayPort 1": "Version 1.1", no external load is connected

*2 When the USB upstream port is not connected, "DP Power Save": "On", "DisplayPort 1": "Version 1.1", no external load is connected

4.1.6 Physical Specifications

Dimensions (W x H x D)	356.5 mm x 482.3 mm – 572.3 mm x 200.0 mm (Tilt: 0°) 356.5 mm x 509.9 mm – 599.9 mm x 276.5 mm (Tilt: 30°)
Dimensions (W x H x D) (Without Stand)	356.5 mm x 464.5 mm x 78.0 mm
Net Weight	Approx. 7.7 kg
Net Weight (Without Stand)	Approx. 4.9 kg
Height Adjustment Range	90 mm (Tilt: 0°)
Tilt	Up 30°, down 5°
Swivel	70°
Rotation	90° (Counterclockwise)

4.1.7 Operating Environmental Requirements

Temperature	0°C – 35°C
Humidity	20 % – 80 % R.H. (no dew condensation)
Air Pressure	540 hPa – 1060 hPa

4.1.8 Transport / Storage Conditions

Temperature	-20°C – 60°C
Humidity	10 % – 90 % R.H. (no dew condensation)
Air Pressure	200 hPa – 1060 hPa

4.2 Compatible Resolutions

The monitor supports the following resolutions.

✓: Supported, -: Not supported

Resolution	Vertical scan frequency (Hz)	DisplayPort		DVI	
		Portrait	Landscape	Portrait	Landscape
720 x 400	70.087	✓	✓	✓	✓
640 x 480	59.940	✓	✓	✓	✓
800 x 600	60.317	✓	✓	✓	✓
1024 x 768	60.004	✓	✓	✓	✓
1280 x 1024	60.020	-	✓	-	✓
1600 x 1200 ^{*1}	60.000	-	✓	-	✓
1200 x 1600 ^{*1}	59.963	✓	-	✓	-

*1 Recommended resolution

4.3 Accessories

The following accessories are available separately.

For the latest information about the optional accessories and information about the latest compatible graphics board, refer to our web site.

(www.eizoglobal.com)

Calibration Kit	RadiCS UX2 Ver.5.1.0 or later RadiCS Version Up Kit Ver.5.1.0 or later
Network QC Management Software	RadiNET Pro Ver.5.1.0 or later
Cleaning Kit	ScreenCleaner
Comfort Light for Reading Rooms	RadiLight
Arm	AAH-02B3W LA-011-W
Panel Protector	RP-915
VESA Adapter for Thin Client or Mini-PC	PCSK-R1
Signal Cable (DVI-D - DVI-D)	DD300 DD200

Appendix

Medical Standard

- It shall be assured that the final system is in compliance to IEC60601-1-1 requirement.
- Power supplied equipment can emit electromagnetic waves, that could influence, limit or result in malfunction of the monitor. Install the equipment in a controlled environment, where such effects are avoided.

Classification of Equipment

- Type of protection against electric shock : Class I
- EMC class: IEC60601-1-2 Group 1 Class B
- Classification of medical device (EU): Class I
- Mode of operation : Continuous
- IP Class : IPX0

EMC Information

The RadiForce series has the capability to properly display medical images.

Environments of Intended Use

The RadiForce series is intended for use in the following environments

- Professional healthcare facility environments such as clinics and hospitals

The following environments are not suitable for the RadiForce series to be used:

- Home healthcare environments
- In the vicinity of high-frequency surgical equipments such as electrosurgical knives
- In the vicinity of short-wave therapy equipments
- RF shielded room of the medical equipment systems for MRI
- In shielded location Special environments
- Installed in vehicles including ambulances
- Other special environments

 **WARNING**

- The RadiForce series requires special precautions regarding EMC and need to be installed. You need to carefully read EMC Information and the "PRECAUTIONS" section in this document, and observe the following instructions when installing and operating the product.

 **WARNING**

- The RadiForce series should not be used adjacent to or stacked with other equipment. If adjacent or stacked use is necessary, the equipment or system should be observed to verify normal operation in the configuration in which it will be used.

 **WARNING**

- When using a portable RF communication equipment, keep it 30 cm (12 inches) or more away from any part, including cables, of the RadiForce series. Otherwise, degradation of the performance of this equipment could result.

 **WARNING**

- Anyone who connects additional equipment to the signal input part or signal output parts, configuring a medical system, is responsible that the system complies with the requirements of IEC60601-1-2.

 **WARNING**

- Do not touch the signal input/output connectors while using the RadiForce series. Otherwise, the displayed image may be affected.

 WARNING
<ul style="list-style-type: none"> • Be sure to use the cables attached to the product, or cables recommended by EIZO. Use of cables other than those recommended by EIZO for this equipment could result in increased electromagnetic emissions or decreased electromagnetic immunity of this equipment and improper operation.

Cable	EIZO Designated Cables	Max. Cable Length	Shielding	Ferrite Core
Signal cable (DisplayPort)	PP300 / PP200	3 m	Shielded	Without Ferrite Cores
Signal cable (DVI)	DD300 / DD200	3 m	Shielded	With Ferrite Cores
USB cable	UU300 / MD-C93	3 m	Shielded	With Ferrite Cores
Power cable (with grounding wire)	-	3 m	Unshielded	Without Ferrite Cores

Technical Descriptions

Electromagnetic emissions

The RadiForce series is intended for use in the electromagnetic environments specified below.

The customer or the user of the RadiForce series should ensure that it is used in such an environment.

Emission test	Compliance	Electromagnetic environment - Guidance
RF emissions CISPR11	Group 1	The RadiForce series uses RF energy only for its internal function. Therefore, its RF emission are very low and are not likely to cause any interference in nearby electronic equipment.
RF emissions CISPR11	Class B	The RadiForce series is suitable for use in all establishments, including domestic establishments and those directly connected to the public low-voltage power supply network that supplies buildings used for domestic purposes.
Harmonic emissions IEC61000-3-2	Class D	
Voltage fluctuations / flicker emissions IEC61000-3-3	Complies	

Electromagnetic immunity

The RadiForce series has been tested at the following compliance levels (C) according to the testing requirements (T) for professional healthcare facility environments specified in IEC60601-1-2.

The customer or the user of the RadiForce series should ensure that it is used in such an environment.

Immunity test	Test level (T)	Compliance level (C)	Electromagnetic environment - Guidance
Electrostatic discharge (ESD) IEC61000-4-2	±8 kV contact discharge ±15 kV air discharge	±8 kV contact discharge ±15 kV air discharge	Floors should be wood, concrete or ceramic tile. If floors are covered with synthetic material, the relative humidity should be at least 30 %.
Electrical fast transients / bursts IEC61000-4-4	±2 kV power lines ±1 kV input / output lines	±2 kV power lines ±1 kV input / output lines	Mains power quality should be that of a typical commercial or hospital environment.
Surges IEC61000-4-5	±1 kV line to line ±2 kV line to ground	±1 kV line to line ±2 kV line to ground	Mains power quality should be that of a typical commercial or hospital environment.
Voltage dips, short interruptions and voltage variations on power supply input lines IEC61000-4-11	0 % U_T (100 % dip in U_T) 0.5 cycles and 1 cycle 70 % U_T (30 % dip in U_T) 25 cycles / 50 Hz 0 % U_T (100 % dip in U_T) 250 cycles / 50 Hz	0 % U_T (100 % dip in U_T) 0.5 cycles and 1 cycle 70 % U_T (30 % dip in U_T) 25 cycles / 50 Hz 0 % U_T (100 % dip in U_T) 250 cycles / 50 Hz	Mains power quality should be that of a typical commercial or hospital environment. If the user of the RadiForce series requires continued operation during power mains interruptions, it is recommended that the RadiForce series be powered from an uninterruptible power supply or a battery.
Power frequency magnetic fields IEC61000-4-8	30 A/m (50 / 60 Hz)	30 A/m	Power frequency magnetic fields should be at levels characteristic of a typical location in a typical commercial or hospital environment. The product should be kept at least 15 cm away from the source of power frequency magnetic fields during use.

Immunity test	Test level (T)	Compliance level (C)	Electromagnetic environment - Guidance
Conducted disturbances induced by RF fields IEC61000-4-6	3 Vrms 150 kHz to 80 MHz 6 Vrms ISM bands between 150 kHz and 80 MHz ^{*1}	3 Vrms 6 Vrms	Portable and mobile RF communications equipment should be used no closer to any part of the RadiForce series, including cables, than the recommended separation distance calculated from the equation applicable to the frequency of the transmitter. Recommended separation distance $d = 1.2\sqrt{P}$ $d = 1.2\sqrt{P}$
Radiated RF fields IEC61000-4-3	3 V/m 80 MHz – 2.7 GHz	3 V/m	$d = 1.2\sqrt{P}$, 80 MHz – 800 MHz $d = 2.3\sqrt{P}$, 800 MHz – 2.7 GHz Where "P" is the maximum output power rating of the transmitter in watts (W) according to the transmitter manufacturer and "d" is the recommended separation distance in meters (m). Field strengths from fixed RF transmitters, as determined by an electromagnetic site survey ^{*2} , should be less than the compliance level in each frequency range ^{*3} . Interference may occur in the vicinity of equipment marked with the following symbol. 

Note

- U_T is the a.c. mains voltage prior to application of the test level.
- At 80 MHz and 800 MHz, the higher frequency range applies.
- These guidelines regarding conducted disturbances induced by RF fields or radiated RF fields may not apply in all situations. Electromagnetic propagation is affected by absorption and reflection from structures, objects and people.

^{*1} The ISM (industrial, scientific and medical) bands between 150 kHz and 80 MHz are 6.765 MHz to 6.795 MHz, 13.553 MHz to 13.567 MHz, 26.957 MHz to 27.283 MHz, and 40.66 MHz to 40.70 MHz.

^{*2} Field strengths from fixed transmitters, such as base stations for radio (cellular/cordless) telephones and land mobile radios, amateur radio, AM and FM radio broadcast and TV broadcast cannot be predicted theoretically with accuracy. To assess the electromagnetic environment due to fixed RF transmitters, an electromagnetic site survey should be considered. If the measured field strength in the location in which the RadiForce series is used exceeds the applicable RF compliance level above, the RadiForce series should be observed to verify normal operation. If

Appendix

abnormal performance is observed, additional measures may be necessary, such as reorienting or relocating the RadiForce series.

- *3 Over the frequency range 150 kHz to 80 MHz, field strengths should be less than 3 V/m.

Recommended separation distances between portable or mobile RF communication equipment and the RadiForce series

The RadiForce series is intended for use in an electromagnetic environment in which radiated RF disturbances are controlled. The customer or the user of the RadiForce series can suppress electromagnetic interference by maintaining a minimum distance (30 cm) between portable and mobile RF communications equipment (transmitters) and the RadiForce series. The RadiForce series has been tested at the following compliance level (C) for the requirements of the proximity electromagnetic field immunity test level (T) for the following RF communication services.

Test frequency (MHz)	Bandwidth ^{*1} (MHz)	Service ^{*1}	Modulation ^{*2}	Test level (T) ^{*3} (V/m)	Compliance level (C) (V/m)
385	380 – 390	TETRA 400	Pulse modulation ^{*2} 18 Hz	27	27
450	430 – 470	GMRS 460, FRS 460	FM ±5 kHz deviation 1 kHz sine	28	28
710	704 – 787	LTE Band 13, 17	Pulse modulation ^{*2} 217 Hz	9	9
745					
780					
810	800 – 960	GSM 800 / 900, TETRA 800, iDEN 820 CDMA 850, LTE Band 5	Pulse modulation ^{*2} 18 Hz	28	28
870					
930					
1720	1700 – 1990	GSM 1800; CDMA 1900; GSM 1900; DECT; LTE Band 1, 3, 4, 25; UMTS	Pulse modulation ^{*2} 217 Hz	28	28
1845					
1970					
2450	2400 – 2570	Bluetooth, WLAN, 802.11 b/g/n, RFID 2450, LTE Band 7	Pulse modulation ^{*2} 217 Hz	28	28
5240	5100 – 5800	WLAN 802.11 a/n	Pulse modulation ^{*2} 217 Hz	9	9
5500					
5785					

*1 For some services, only the uplink frequencies are included.

*2 The carrier is modulated using a 50 % duty cycle square wave signal.

*3 Test levels were calculated with maximum power and 30 cm of separation distance.

The customer or the user of the RadiForce series suppress interference caused by proximity magnetic fields by maintaining a minimum distance (15 cm) between RF transmitters and the RadiForce series. The RadiForce series has been tested at the following compliance levels (C) for the requirements of the proximity magnetic field immunity test levels (T).

Test frequency	Modulation	Test level (T) (A/m)	Compliance level (C) (A/m)
134.2 kHz	Pulse modulation* ¹ 2.1 kHz	65	65
13.56 MHz	Pulse modulation* ¹ 50 kHz	7.5	7.5

*1 The carrier is modulated using a 50 % duty cycle square wave signal.

For other portable and mobile RF communication equipments (transmitters), minimum distance between portable and mobile RF communications equipment (transmitters) and the RadiForce series as recommended below, according to the maximum output power of the communications equipment.

Rated maximum output power of transmitter (W)	Separation distance according to frequency of transmitter (m)		
	150 kHz – 80 MHz $d = 1.2\sqrt{P}$	80 MHz – 800 MHz $d = 1.2\sqrt{P}$	800 MHz – 2.7 GHz $d = 2.3\sqrt{P}$
0.01	0.12	0.12	0.23
0.1	0.38	0.38	0.73
1	1.2	1.2	2.3
10	3.8	3.8	7.3
100	12	12	23

For transmitters rated at a maximum output power not listed above, the recommended separation distance "d" in meters (m) can be estimated using the equation applicable to the frequency of the transmitter, where "P" is the maximum output power rating of the transmitter in watts (W) according to the transmitter manufacturer.

Note
<ul style="list-style-type: none"> At 80 MHz and 800 MHz, the separation distance for a higher frequency range must be applied. These guidelines regarding conducted disturbances induced by RF fields or radiated RF fields may not apply in all situations. Electromagnetic propagation is affected by absorption and reflection from structures, objects and people.

Information for Radio Interference

For U.S.A, Canada Only

FCC Supplier's Declaration of Conformity

We, the Responsible Party

Company: EIZO Inc.

Address: 5710 Warland Drive, Cypress, CA 90630

Phone: (562) 431-5011

declare that the product

Trade name: EIZO

Model: RadiForce RX270

is in conformity with Part 15 of the FCC Rules. Operation of this product is subject to the following two conditions: (1) this device may not cause harmful interference, and (2) this device must accept any interference received, including interference that may cause undesired operation.

This equipment has been tested and found to comply with the limits for a Class B digital device, pursuant to Part 15 of the FCC Rules. These limits are designed to provide reasonable protection against harmful interference in a residential installation. This equipment generates, uses, and can radiate radio frequency energy and, if not installed and used in accordance with the instructions, may cause harmful interference to radio communications. However, there is no guarantee that interference will not occur in a particular installation. If this equipment does cause harmful interference to radio or television reception, which can be determined by turning the equipment off and on, the user is encouraged to try to correct the interference by one or more of the following measures.

- Reorient or relocate the receiving antenna.
- Increase the separation between the equipment and receiver.
- Connect the equipment into an outlet on a circuit different from that to which the receiver is connected.
- Consult the dealer or an experienced radio/TV technician for help.

Changes or modifications not expressly approved by the party responsible for compliance could void the user's authority to operate the equipment.

Note

Use the attached specified cable below or EIZO signal cable with this monitor so as to keep interference within the limits of a Class B digital device.

- AC Cord
- Shielded Signal Cable (enclosed)

Canadian Notice

This Class B information technology equipment complies with Canadian ICES-003.

Cet équipement informatique de classe B est conforme à la norme NMB-003 du Canada.



EIZO Corporation 
153 Shimokashiwano, Hakusan, Ishikawa 924-8566 Japan

EIZO GmbH 
Carl-Benz-Straße 3, 76761 Rülzheim, Germany

艺卓显像技术(苏州)有限公司
中国苏州市苏州工业园区展业路8号中新科技工业坊5B

EIZO Limited 
1 Queens Square, Ascot Business Park, Lyndhurst Road,
Ascot, Berkshire, SL5 9FE, UK

EIZO AG 
Moosacherstrasse 6, Au, CH-8820 Wädenswil, Switzerland



www.eizoglobal.com

00N0N337C1
IFU-RX270

Copyright © 2022 - 2023 EIZO Corporation. All rights reserved.

3rd Edition – September 29th, 2023