

User's Manual

FlexScan[®] MH240W

Color LCD Monitor

Important

Please read this User's Manual and Setup Manual (separate volume) carefully to familiarize yourself with safe and effective usage.

Please retain this manual for future reference.

The latest User's Manual is available for download from our site:
<http://www.eizo.com>

It shall be assured that the final system is in compliance to IEC60601-1-1 requirements.

PRECAUTIONS

Notice for this monitor

CONTENTS

Chapter 1 Features and Overview

- 1-1 Features
- 1-2 Names of Switches
- 1-3 Functions

Chapter 2 Basic Operation

- 2-1 Operation Switch Usage
- 2-2 Menu Operation
- 2-3 Resumption of Default Settings
- 2-4 Locking Switches

Chapter 3 Settings and Adjustment

- 3-1 Input Signal Switching
- 3-2 Screen Adjustment
- 3-3 Color Adjustment
- 3-4 Sound Adjustment
- 3-5 PinP (Picture in Picture) Display
- 3-6 Screen Size Changing
- 3-7 Off Timer Setting
- 3-8 Monitor Power-saving Mode Setting
- 3-9 Power Indicator/EIZO Logo Display Setting
- 3-10 Beeper Setting
- 3-11 Information Checking
- 3-12 Language Setting to be displayed

Chapter 4 Troubleshooting

Chapter 5 Reference

- 5-1 Attaching an Arm
- 5-2 Specifications
- 5-3 Glossary
- 5-4 Preset Timing





How to Setup

Please read the Setup Manual (separate volume)



SAFETY SYMBOLS

This manual uses the safety symbols below. They denote critical information. Please read them carefully.

	<p>WARNING Failure to abide by the information in a WARNING may result in serious injury and can be life threatening.</p>	 <p>CAUTION Failure to abide by the information in a CAUTION may result in moderate injury and/or property or product damage.</p>
	<p>Indicates a prohibited action.</p>	
	<p>Indicates a mandatory action that must be followed.</p>	

Power supplied equipment can emit electromagnetic waves, that could influence, limit or result in malfunction of the monitor. Install the equipment in a controlled environment, where such effects are avoided.

This is a monitor intended for use in a medical image system.

As an ENERGY STAR® Partner, EIZO NANA O CORPORATION has determined that this product meets the ENERGY STAR guidelines for energy efficiency.



Using the special functions, such as screen size change (ex. changing the horizontal and vertical ratio of images input) for commercial purposes or for the purpose of showing in public may violate copyright laws.

Product specification may vary with sales areas.
Confirm the specification in the manual written in language of the region of purchase.

Copyright© 2008 EIZO NANA O CORPORATION All rights reserved.

No part of this manual may be reproduced, stored in a retrieval system, or transmitted, in any form or by any means, electronic, mechanical, or otherwise, without the prior written permission of EIZO NANA O CORPORATION. EIZO NANA O CORPORATION is under no obligation to hold any submitted material or information confidential unless prior arrangements are made pursuant to EIZO NANA O CORPORATION's receipt of said information. Although every effort has been made to ensure that this manual provides up-to-date information, please note that EIZO monitor specifications are subject to change without notice.

ENERGY STAR is a U.S. registered mark.
Apple and Macintosh are registered trademarks of Apple Inc.
VGA is a registered trademark of International Business Machines Corporation.
VESA is a registered trademark of Video Electronics Standards Association.
Windows and Xbox 360 are registered trademarks of Microsoft Corporation.
NEC is a registered trademark of NEC Corporation.
HDMI, the HDMI logo and High-Definition Multimedia Interface are trademarks or registered trademarks of HDMI Licensing LLC.
FlexScan, ScreenManager and EIZO are registered trademarks of EIZO NANA O CORPORATION in Japan and other countries.

⚠ PRECAUTIONS

IMPORTANT

- This product has been adjusted specifically for use in the region to which it was originally shipped. If the product is used outside the region, it may not operate as specified in the specifications.
- To ensure personal safety and proper maintenance, please read carefully this section and the caution statements on the monitor.

[Location of Caution Statement]

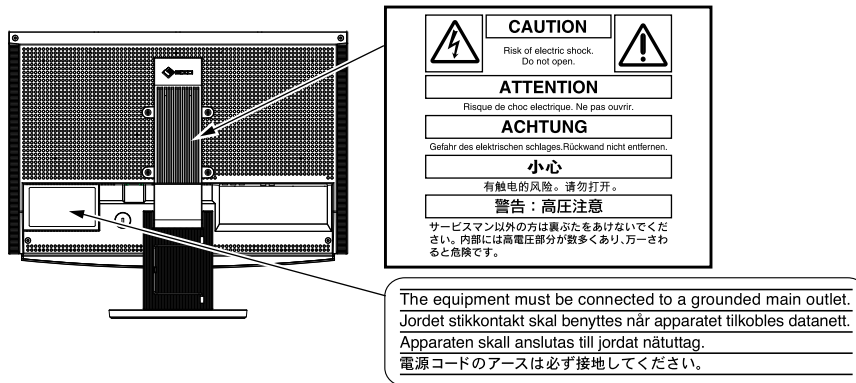

[Symbols on the unit]

Symbol	Location	This symbol indicates
	Front	Power switch Touch to turn the monitor's power on or off.
	Rear Name Plate	Alternating current
	Rear	Alerting electrical hazard
	Rear	Caution Refer to SAFETY SYMBOLS section in this manual.

⚠ WARNING

If the unit begins to emit smoke, smells like something is burning, or makes strange noises, disconnect all power connections immediately and contact your dealer for advice.

Attempting to use a malfunctioning unit may result in fire, electric shock, or equipment damage.

Do not open the cabinet or modify the unit.

Opening the cabinet or modifying the unit may result in fire, electric shock, or burn.



Refer all servicing to qualified service personnel.

Do not attempt to service this product yourself as opening or removing covers may result in fire, electric shock, or equipment damage.

WARNING

Keep small objects or liquids away from the unit.

Small objects accidentally falling through the ventilation slots into the cabinet or spillage into the cabinet may result in fire, electric shock, or equipment damage.

If an object or liquid falls/spills into the cabinet, unplug the unit immediately. Have the unit checked by a qualified service engineer before using it again.

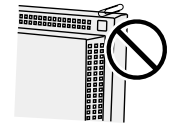

Place the unit at the strong and stable place.

A unit placed on an inadequate surface may fall and result in injury or equipment damage.

If the unit falls, disconnect the power immediately and ask your dealer for advice. Do not continue using a damaged unit. Using a damaged unit may result in fire or electric shock.

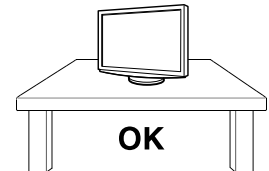

Use the unit in an appropriate location.

Not doing so may result in fire, electric shock, or equipment damage.

- Do not place outdoors.
- Do not place in the transportation system (ship, aircraft, trains, automobiles, etc.)
- Do not place in a dusty or humid environment.
- Do not place in a location where the steam comes directly on the screen.
- Do not place near heat generating devices or a humidifier.
- Do not place in an inflammable gas environment.

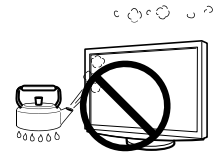

To avoid danger of suffocation, keep the plastic packing bags away from babies and children.

Use the enclosed power cord and connect to the standard power outlet of your country.

Be sure to remain within the rated voltage of the power cord.

Not doing so may result in fire or electric shock.

To disconnect the power cord, grasp the plug firmly and pull.

Tugging on the cord may damage and result in fire or electric shock.



The equipment must be connected to a grounded main outlet.

Failure to do so may result in fire or electric shock.



WARNING

Use the correct voltage.

- The unit is designed for use with a specific voltage only. Connection to another voltage than specified in this User's Manual may cause fire, electric shock, or equipment damage.
 - Do not overload your power circuit, as this may result in fire or electric shock.
-

Handle the power cord with care.

- Do not place the cord underneath the unit or other heavy objects.
- Do not pull on or tie the cord.

If the power cord becomes damaged, stop using it. Use of a damaged cord may result in fire or electric shock.



Never touch the plug and power cord if it begins to thunder.

Touching them may result in electric shock.

When attaching an arm stand, please refer to the user's manual of the arm stand and install the unit securely.

Not doing so may cause the unit to become unattached, which may result in injury or equipment damage. When the unit is dropped, please ask your dealer for advice. Do not continue using a damaged unit. Using a damaged unit may result in fire or electric shock. When reattaching the tilt stand, please use the same screws and tighten them securely.

Do not touch a damaged LCD panel directly with bare hands.

The liquid crystal that may leak from the panel is poisonous if it enters the eyes or mouth. If any part of the skin or body comes in direct contact with the panel, please wash thoroughly. If some physical symptoms result, please consult your doctor.



Lamps contain mercury, dispose according to local, state or federal laws.

CAUTION

Handle with care when carrying the unit.

Disconnect the power cord and cables when moving the unit. Moving the unit with the cord attached is dangerous. It may result in injury.

When handling the unit, grip the bottom of the unit firmly with both hands ensuring the panel faces outward before lifting.

Dropping the unit may result in injury or equipment damage.

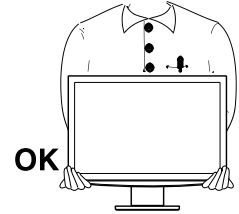

Do not block the ventilation slots on the cabinet.

- Do not place any objects on the ventilation slots.
- Do not install the unit in a closed space.
- Do not use the unit laid down or upside down.

Blocking the ventilation slots prevents proper airflow and may result in fire, electric shock, or equipment damage.

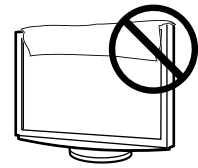

Do not touch the plug with wet hands.

Doing so may result in electrical shock.



Use an easily accessible power outlet.

This will ensure that you can disconnect the power quickly in case of a problem.

Do not set the sound volume too high when using a headphone.

Doing so may damage your hearing ability.



Periodically clean the area around the plug.

Dust, water, or oil on the plug may result in fire.

Unplug the unit before cleaning it.

Cleaning the unit while it is plugged into a power outlet may result in electric shock.

If you plan to leave the unit unused for an extended period, disconnect the power cord from the wall socket after turning off the power switch for the safety and the power conservation.

Notice for this monitor

This product is suited to displaying endoscope images.

This product has been adjusted specifically for use in the region to which it was originally shipped. If the product is used outside the region, it may not operate as specified in the specifications.

This product may not be covered by warranty for uses other than those described in this manual.

The specifications noted in this manual are only applicable for power cords and signal cables specified by us.

Use optional products manufactured or specified by us with this product.

As it takes about 30 minutes for the performance of electrical parts to stabilize, adjust the monitor 30 minutes or more after the monitor power has been turned on.

In order to suppress the luminosity change by long-term use and to maintain the stable luminosity, use of a monitor in lower brightness is recommended.

When the screen image is changed after displaying the same image for extended periods of time, an afterimage may appear. Use the screen saver or timer to avoid displaying the same image for extended periods of time.

Periodic cleaning is recommended to keep the monitor looking new and to prolong its operation lifetime. (Refer to "[Cleaning](#)" on the next page.)

The LCD panel is manufactured using high-precision technology. However, missing pixels or lit pixels may appear on the LCD panel, this is not malfunction.
Percentage of effective pixels: 99.9994% or higher.

The backlight of the LCD panel has a fixed life span. When the screen becomes dark or begins to flicker, please contact your dealer.

Do not press on the panel or edge of the frame strongly, as this may result in the display malfunction, such as the interference patterns, etc. If pressure is continually applied to the LCD panel, it may deteriorate or damage your LCD panel. (If the pressure marks remain on the LCD panel, leave the monitor with a white or black screen. The symptom may disappear.)

Do not scratch or press on the panel with any sharp objects, such as a pencil or pen as this may result in damage to the panel. Do not attempt to brush with tissues as this may scratch the LCD panel.

When the monitor is cold and brought into a room or the room temperature goes up quickly, dew condensation may occur inside and outside the monitor. In that case, do not turn the monitor on and wait until dew condensation disappears, otherwise it may cause some damages to the monitor.

When using this product, just in case the images cannot be displayed during use, displaying images on multiple monitors or preparing an alternative monitor is highly recommended.

Periodic maintenance is recommended for stable performance of your monitor. Please ask your dealer for maintenance (non-free).

Cleaning

Attention

- Never use any solvents or chemicals, such as thinner, benzene, wax, alcohol, disinfectant, and abrasive cleaner, which may damage the cabinet or LCD panel.
-

NOTE

- Optional ScreenCleaner is recommended for cleaning the panel surface.
-

[LCD Panel]

- Clean the LCD panel with a soft cloth such as cotton cloth or lens cleaning paper.
- Remove persistent stains gently with a cloth dampened with a little water, and then clean the LCD panel again with a dry cloth for better finishing.

[Cabinet]

Clean the cabinet with a soft cloth dampened with a little mild detergent.

To use the monitor comfortably

- An excessively dark or bright screen may affect your eyes. Adjust the brightness of the monitor according to the environmental conditions.
- Staring at the monitor for a long time tires your eyes. Take a 10-minute rest every hour.

CONTENTS

PRECAUTIONS	3	3-5 PinP (Picture in Picture) Display	28
Notice for this monitor	7	• To display the PC input signal screen (Main Window) and the VIDEO input signal screen (Sub-Window) simultaneously [PinP]	28
Cleaning	8	• To change the Sub-Window position [Sub-Window Position].....	30
To use the monitor comfortably	8	• To set the translucent level for Sub-Window [Translucent].....	30
Chapter 1 Features and Overview	10	• To select the Sub-Window display size [Sub-Window Size].....	30
1-1 Features	10	3-6 Screen Size Changing	31
1-2 Names of Switches	12	• To change the screen image/projected image size appearing on the screen [Screen Size]	31
1-3 Functions	13	3-7 Off Timer Setting	33
Chapter 2 Basic Operation	15	• To set monitor power-off time [Off Timer]	33
2-1 Operation Switch Usage	15	3-8 Monitor Power-saving Mode Setting	33
2-2 Menu Operation	16	• To set the resume conditions from the power-saving mode [Signal Detection].....	33
• Basic operation of the Input Selection menu....	16	3-9 Power Indicator/EIZO Logo Display Setting	34
• Basic operation of the Setting menu	16	• To turn off the power indicator while a screen is displayed [Power Indicator]	34
2-3 Resumption of Default Settings	17	• To set EIZO logo display/no EIZO logo display when the monitor turns on [EIZO Logo Appearing Function].....	34
• To reset the color adjustment [Reset].....	17	3-10 Beeper Setting	34
• To reset all settings [Reset]	17	• To set the beeper [Beep]	34
2-4 Locking Switches	17	3-11 Information Checking	35
• To lock the available functions [Operation Lock].....	17	• To check settings, usage time, etc. [Information]	35
Chapter 3 Settings and Adjustment	18	3-12 Language Setting to be displayed	35
3-1 Input Signal Switching	18	• To set the language displayed in the menu [Language]	35
• To switch the input signal for the desired image sent from the equipment [Input Selection].....	18	Chapter 4 Troubleshooting	36
3-2 Screen Adjustment (Only for analog input signal from a PC)	19	• Messages List	40
3-3 Color Adjustment	23	Chapter 5 Reference	41
Simple Adjustment	23	5-1 Attaching an Arm	41
• To select the color mode [Color Mode].....	23	5-2 Specifications	42
Advanced Adjustment	24	5-3 Glossary	46
• To adjust/set Color Mode.....	24	5-4 Preset Timing	48
• Adjustment items.....	25		
3-4 Sound Adjustment	27		
• To adjust [Volume/Treble/Bass/Balance/Sound Level].....	27		

Chapter 1 Features and Overview

Thank you very much for choosing an EIZO color LCD monitor.

1-1 Features

- 24" wide format LCD with Video signal input connector
- Resolution 1920 dots × 1200 lines
- Equipped with the ContrastEnhancer and OutlineEnhancer functions
- Equipped with PinP (Picture in Picture) function
- Enable to adjust the screen brightness automatically corresponding to the brightness of the image and the environment.
- Employing the slide bar and realizing the excellent operability.
- The ArcSwing 2 Stand enables to adjust the monitor height and monitor angle freely
- Equipped with the Utility Software, "ScreenManager Pro for LCD (Windows)", which is operated via a keyboard or a mouse.

[Applicable to PC signal input]

- DVI-D connector × 1, D-Sub mini 15-pin connector × 1 (two input connectors)
- Horizontal scan frequency and Vertical scan frequency are as follows:

Horizontal scan frequency	Digital input signal	31.5 ~ 76 kHz: each preset signal ±1 kHz
	Analog input signal	31.5 ~ 80 kHz: each preset signal ±1 kHz
Vertical scan frequency	Digital input signal	59 ~ 61 Hz: each preset signal ±1 Hz (VGA TEXT: 69 ~ 71 Hz) (49 ~ 51 Hz is also available@720p/1080p*)
	Analog input signal	55 ~ 76 Hz: each preset signal ±1 Hz (49 ~ 51 Hz is also available@720p/1080p*)

* For some AV equipment such as Microsoft Xbox 360

- Compliance with frame synchronization mode (49.60 ~ 50.40 Hz, 59.50 ~ 60.50 Hz)
- Equipped with USB ports (Upstream × 2, Downstream × 2)
- Compliance with DVI digital input signal (HDCP)
- Equipped with USB audio function
- Enable to use connected USB devices on two PCs

[Applicable to Video signal input]

- HDMI connector × 2, S-Video/Composite Video terminal × 1, D terminal × 1 (four input connectors)

NOTE

- The stand of the unit can be replaced with an arm or another stand. (Refer to "5-1 Attaching an Arm" on [page 41.](#))

Connecting to peripheral devices equipment

Speakers

(with built-in amplifier)

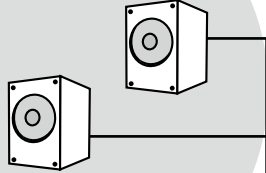

Allows you to enjoy sound from a connected PC or AV equipment, etc.

NOTE

- Enables you to adjust the speaker volume connected to the monitor using the volume adjustment function of the monitor. [page 27](#)
- Enables you to enjoy sound by connecting a headphone to the headphone jack.

PC

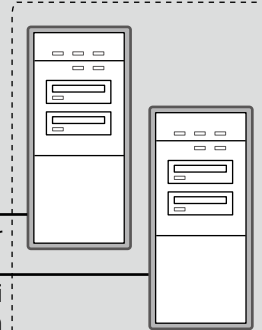

DVI connector

D-Sub mini 15-pin connector

Enables you to use as a monitor by connecting to a Windows PC or a Macintosh.

Attention

- The [USB] setting is required to change depending on a PC used. [page 18](#)

USB devices



Keyboard

Mouse

(Also available to connect a printer or a scanner, etc.)

Attention

- Use a PC/OS applicable to USB devices.
[Applicable OS]
 - Windows 2000/XP/Vista
 - Mac OS 8.5.1 or later

AV equipment

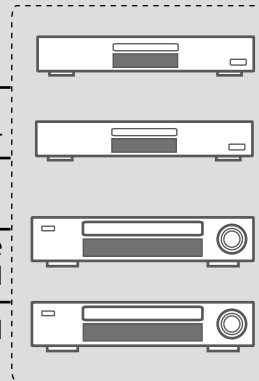

HDMI connector

S-Video/Composite Video terminal

D terminal

DVD player, Video, etc.

Enables you to display projected images by connecting a DVD, Video, etc.

1-2 Names of Switches

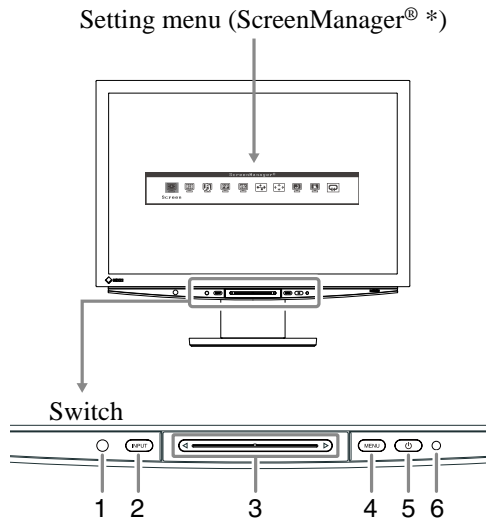

1. Sensor (Detects the environmental brightness.)
2. Input Signal Selection switch (INPUT)
3. Slide bar
4. Menu switch (MENU)
5. Power switch (⏻)
6. Power indicator

Indicator status	Operation status
Blue	The screen is displayed
Orange	Power saving
Off	Power off

* ScreenManager® is an EIZO's nickname of the Setting menu.
 (In this manual, the setting/adjustment item names in the Setting menu are put in angle brackets < >, ex.: <Color>)

NOTE

- As well as touching ⏻, if you touch the MENU, INPUT or slide bar, the monitor turns on.
- While the screen is displayed, the power indicator that is lighting blue can be turned off (see "Power Indicator/EIZO Logo Display Setting," on [page 34](#)).

1-3 Functions

Switching the Input Signal

Single display



Input Selection menu (As for the menu operation, refer to [page 16](#).)

- To switch the input signal for the desired display sent from the equipment [Input Selection] ... see [page 18](#)

PinP (Picture in Picture) display

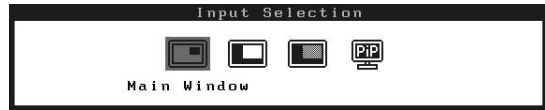

- To switch the input signal for the Main Window/ Sub-Window see [page 29](#)
- To hide the Sub-Window display with its sound being heard [Sub-Window Off] see [page 29](#)

Setting/Adjusting the Monitor

(Only for analog input signal from PC: PC 2 Input)



Setting menu
(As for the menu operation, refer to [page 16](#).)

1 Screen Adjustment Page 19

Screen menu

- Adjusting the screen automatically [Auto Screen Adjust]

2 Advanced Screen Adjustment

- To eliminate vertical bars [Clock] see [page 20](#)
- To remove flickering or blurring [Phase] see [page 21](#)
- To correct screen position [Hor.Position] see [page 21](#)
[Ver.Position]..... see [page 21](#)
- To set when the image is not displayed with proper resolution [Resolution]..... see [page 37](#)
- To adjust color gradation automatically [Auto Range Adjust] see [page 22](#)
- To set when noise appears on the screen [Signal Filter] see [page 37](#)

PinP (Picture in Picture) Display Page 28

PinP Settings menu

- To display the PC input signal screen (Main Window) and Video input signal screen (Sub-Window) on the monitor simultaneously [PiP]..... see [page 28](#)
- To change the Sub-Window position [Sub-Window Position] see [page 30](#)
- To set the translucent level for Sub-Window [Translucent]..... see [page 30](#)
- To select the Sub-Window display size [Sub-Window Size] see [page 30](#)

Color Adjustment (Simple Adjustment) Page 23

Color menu

- To select the color mode [Color Mode]

Color Adjustment (Advanced Adjustment) Page 24

- [Brightness / Black Level / Contrast / Saturation / Hue / Temperature / OutlineEnhancer / ContrastEnhancer / Gain / Gamma / Noise Filter / I/P Conversion] can be set for each mode. Settable functions vary with the display mode.

Resumption of Default Settings

- To reset the color adjustment [Reset] see [page 17](#)

Sound Adjustment Page 27

Sound menu

- To adjust [Volume / Treble / Bass / Balance / Sound Level]

- [] stands for the function name.
- Settable functions differ depending on the input signal.
(Refer to "Setting menu list" on [page 44](#).)

Setting/Adjusting the Monitor (Continued)



Setting menu
(As for the menu operation,
refer to [page 16.](#))

Resumption of Default Settings Page 17

- To reset all settings [Reset]

Monitor Settings menu

Language Setting to be displayed

- To set the language displayed in the menu [Language] see [page 35](#)

Adjusting the Brightness automatically

- To adjust the screen brightness automatically corresponding to the brightness of the image and the environment [BrightRegulator] see [page 26](#)

Monitor Power-saving Mode Setting

- To set the resume conditions from the power-saving mode [Signal Detection]..... see [page 33](#)

Power Indicator Setting

- To turn off the Power indicator while a screen is displayed [Power Indicator] see [page 34](#)

Beeper Setting

- To set the beeper [Beep]..... see [page 34](#)

Auto Screen Size Changing

- To change the screen size automatically according to the aspect information of the input signal [Auto Screen Size] see [page 31](#)

Color Space Setting

- To set when the image color is not displayed correctly [Color Space] see [page 39](#)

Field Rate Setting

- To select the setting according to the area where the monitor is used [Field Rate] ... see [page 39](#)

Information Checking Page 35

Information menu

- To check settings, usage time, etc. [Information]

Off Timer Setting Page 33

Off Timer menu

- To set monitor power-off time [Off Timer]

EIZO Logo Display Setting Page 34

- To set EIZO logo display/no EIZO logo display when the monitor turns on [EIZO Logo Appearing Function]

Changing the USB Setting Page 18

USB menu

- To change the setting according to the PC used (when USB is connected) [USB]

Locking Switches Page 17

- To lock the available functions [Operation Lock]

Screen Size Changing Page 31

Screen Size menu

- To change the screen image/projected image size appearing on the screen [Screen Size]

- [] stands for the function name.
- Settable functions differ depending on the input signal.
(Refer to "Setting menu list" on [page 44.](#))

Chapter 2 Basic Operation

2-1 Operation Switch Usage

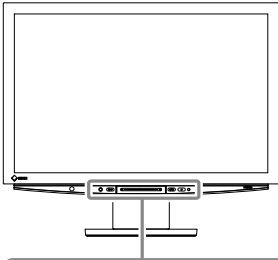

■ Turning the power On/Off

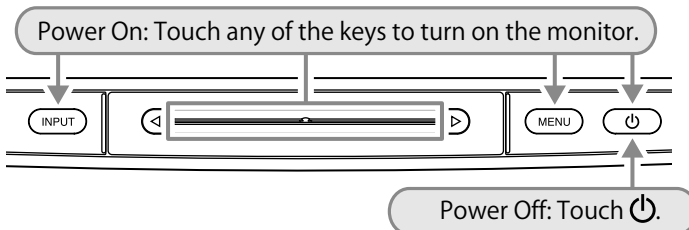

■ Displaying/Quitting a menu

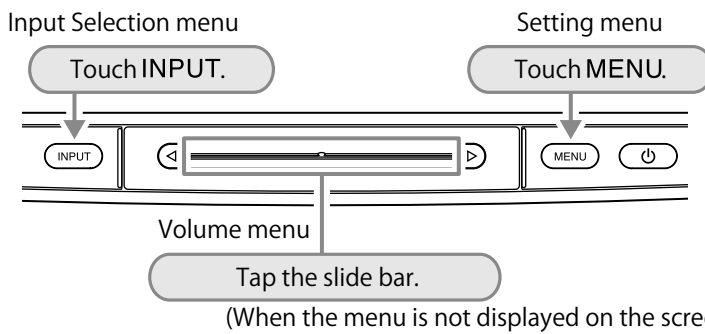

■ Selecting a menu item Setting and Adjusting

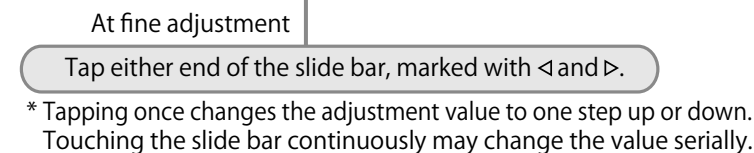
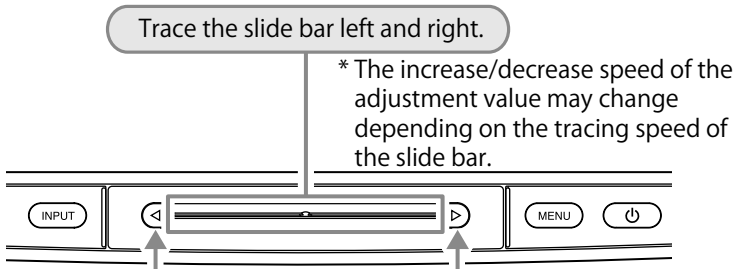

■ Fixing an item Deciding the setting and adjusting value

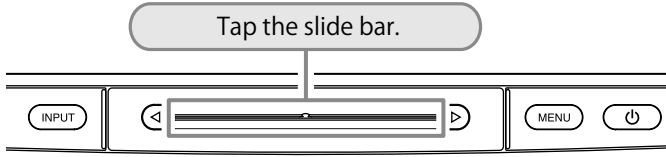

NOTE

- There are three methods of operation:

- Touching the switch

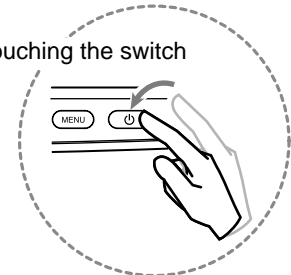

- Tapping the slide bar

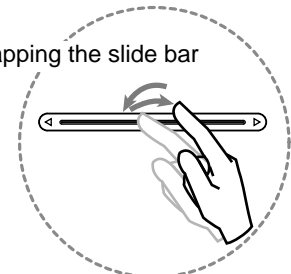

- Tracing the slide bar

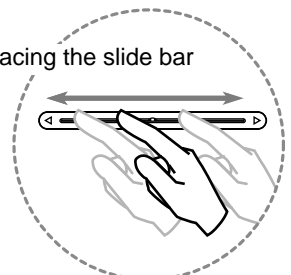

2-2 Menu Operation

• Basic operation of the Input Selection menu

[Displaying the Input Selection menu and selecting the input signal]

- (1) Touch INPUT of the operation switch.
The Input Selection menu appears.
- (2) Trace the slide bar left and right to select the input signal and tap the slide bar.
The screen image appears.

[Quitting the Input Selection Menu]

- (1) Touch INPUT.
The Input Selection menu quits.

• Basic operation of the Setting menu

[Displaying the Setting menu and selecting function]

- (1) Touch MENU of the operation switch.
The Main menu appears.
- (2) Trace the slide bar left and right to select the function and tap the slide bar.
The Sub menu appears.
- (3) Trace the slide bar left and right to select the function and tap the slide bar.
The setting/adjustment menu appears.
- (4) Trace the slide bar left and right to set/adjust the monitor and tap the slide bar.
The setting/adjustment value is saved.

[Quitting the Setting Menu]

- (1) Touch MENU.
The Setting menu quits.

NOTE

- Some menus may not have a sub-menu.

2-3 Resumption of Default Settings

• To reset the color adjustment [Reset]

Only the hue in the color mode currently set will revert to the default settings (factory settings).

[Procedure]

- (1) Choose the <Color> icon in the Setting menu and tap the slide bar.
- (2) Choose the <Reset> icon in the <Color> menu and tap the slide bar.
“Your current color data will be lost.” appears on the screen.
- (3) Trace the slide bar left and right to select “Reset” and tap the slide bar.
The reset operation is completed.

• To reset all settings [Reset]

Reset all the settings/adjustments status except for [Field Rate], [USB] and [Volume] to the default settings (factory settings).

[Procedure]

- (1) Choose the <Reset> icon in the Setting menu and tap the slide bar.
“All settings except for the field rate and USB are reset.” appears on the screen.
- (2) Trace the slide bar left and right to select “Reset” and tap the slide bar.
The reset operation is completed.

2-4 Locking Switches

• To lock the available functions [Operation Lock]

This function enables you to lock the switches to retain the setting/adjustment set once and restrict the available functions.

[Locking]

- (1) Touch  to turn off the monitor.
- (2) Touch MENU for approx. three seconds.
The operation lock is performed (“Operation Lock: ON” is displayed) and the screen is displayed with the operation lock.

[Unlocking]

- (1) Touch  to turn off the monitor.
- (2) Touch MENU for approx. three seconds.
The operation lock is released (“Operation Lock: Off” is displayed) and the screen is displayed with the operation unlock.

NOTE

- For default settings, refer to “Main default settings (factory settings)” on [page 45](#).

NOTE

- The following operations are available in the locked status.
 - Power ON/OFF by touching .
 - Power ON by touching INPUT, MENU or the slide bar.
 - Operation lock function ON/OFF
 - EIZO Logo appearing function ON/OFF ([Page 34](#))

Chapter 3 Settings and Adjustment

3-1 Input Signal Switching

- To switch the input signal for the desired image sent from the equipment [Input Selection]

[Procedure]

- (1) Touch INPUT.
The Input Selection menu appears.
- (2) Trace the slide bar left and right to select the input signal for the desired image sent from the equipment or tap the slide bar.
The desired image appears.

■ When connecting a PC with USB connection [USB]

Change the [USB] setting according to the input signal of the PC used.

Settings	Using status
PC 1 (Digital signal)	When using PC 1.
PC 2 (Analog signal)	When using PC 2.

[Procedure]

- (1) Choose the <USB> icon in the Setting menu and tap the slide bar.
The <USB> menu appears.
- (2) Trace the slide bar left and right to select either “PC 1” or “PC 2” and tap the slide bar.
The USB setting is completed.
[When the following message appears]
When the following message appears, “If the USB setting is changed, the USB connection to the selected PC will be lost. Do you change the setting?” confirm on the right (for changing the USB setting) to proceed the step 3.
- (3) Trace the slide bar left and right to select “Yes” and tap the slide bar.
The USB setting is completed.

NOTE

- When “PinP” is selected, the monitor display changes to PinP (Picture in Picture) mode.
- When switching the input signal in the PinP mode, refer to [page 29](#).

Attention

- If the [USB] setting is not set properly, the USB devices connected to the monitor may not work or no sound may come out from the speakers.
- Please note the following when changing the setting.
 - When connecting a memory device such as a USB memory to the monitor, the data may be lost and damaged. Be sure to change the USB setting after removing the memory device.
 - When an application such as a sound playback, etc. works, the sound may not output if the setting is returned to the original. Be sure to change the USB setting after exiting from the application.

3-2 Screen Adjustment (Only for analog input signal from a PC)

The monitor screen adjustment is used to suppress flickering of the screen or adjust screen position and screen size correctly according to the PC to be used. To use the monitor comfortably, adjust the screen when the monitor is set up for the first time or when the settings of the PC in use are updated. No adjustment is required when the image appears correctly.

The Auto Screen Adjust function works in the following cases:

- When a signal is input into the monitor for the first time.
- When a signal is input into the monitor for the first time after the resolution or refresh rate of input signals is changed.

[Adjustment Procedures]

1 Perform the auto screen adjustment.

- To adjust flickering, screen position, and screen size automatically [Auto Screen Adjust]

- (1) Choose the <Screen> icon in the Setting menu and tap the slide bar.
The <Screen> menu appears.
- (2) Choose the <Auto Screen Adjust> icon in the <Screen> menu and tap the slide bar.
“Your current setting will be lost, if you perform “Auto Screen Adjust”. Do you continue?” appears on the screen.
- (3) Trace the slide bar left and right to select “Yes” and tap the slide bar.
The Auto Screen Adjust function is activated and the clock, phase and screen position are adjusted automatically.

2 Prepare the display pattern for the analog display adjustment.

- (1) Load the “EIZO LCD Utility Disk” to your PC.
- (2) For Windows PC: Start the “Screen Adjustment Utility” from the startup menu on the disk.
For other than Windows PC: Use the screen adjustment pattern files.

- If the screen is displayed correctly : go to step 5
- If the screen is not displayed correctly : go to step 3

NOTE

- When digital input signals are used, images are displayed correctly based on the preset data of the monitor. No screen adjustment is required.

Attention

- The Auto Screen Adjust function does not work for the input signal of low resolution, such as VGA, etc.
- Wait 30 minutes or more from monitor power on before starting the color adjustment.

Attention

- This function works correctly when an image is fully displayed over the Windows or Macintosh display area. It does not work properly when an image is displayed only on a part of the screen (DOS prompt window, for example) or when a black background (wallpaper, etc.) is in use.
- The Auto Adjust function may not work properly with some graphics boards.

NOTE

- When the screen image is not displayed with the proper resolution even after Auto Screen Adjust is performed, set the resolution of the input signal manually. If the resolution is set, the [Auto Screen Adjust] is performed again. (Refer to Chapter 4, “Troubleshooting” on [page 37.](#))

NOTE

- For how to open and use the screen adjustment pattern files, refer to the “Readme.txt” or the “Readme” file on the disk. When you are using a Macintosh PC, you can open the file directly from the start menu of the disk.

3 Perform the auto screen adjustment again with the analog screen adjustment pattern displayed.

- **To adjust flickering, screen position, and screen size automatically [Auto Screen Adjust]**

- (1) Display Pattern 1 in full screen on the monitor using the “Screen Adjustment Utility” or the screen adjustment pattern files.

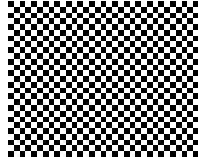

- (2) Choose the <Screen> icon in the Setting menu and tap the slide bar.
The <Screen> menu appears.
- (3) Choose the <Auto Screen Adjust> icon in the <Screen> menu and tap the slide bar.
“Your current setting will be lost, if you perform “Auto Screen Adjust”. Do you continue?” appears on the screen.
- (4) Trace the slide bar left and right to select “Yes” and tap the slide bar.
The Auto Screen Adjust function is activated and the clock, phase and screen position are adjusted automatically.

- **If the screen is displayed correctly : go to step 5**
- **If the screen is not displayed correctly : go to step 4**

4 Perform the advanced adjustment in the <Screen> menu.

- **To eliminate vertical bars [Clock]**

- (1) Choose the <Clock> icon in the <Screen> menu and tap the slide bar.
The <Clock> menu appears.
- (2) Trace the slide bar left and right to eliminate the vertical bars and tap the slide bar.
The adjustment is completed.



NOTE

- Trace the slide bar slowly to adjust since the adjustment point is easily missed.
- When blurring, flickering or bars appear on the screen after adjustment, proceed to [Phase] to remove flickering or blurring.

- **To remove flickering or blurring [Phase]**

(1) Choose the <Phase> icon in the <Screen> menu and tap the slide bar.
The <Phase> menu appears.

(2) Trace the slide bar left and right to remove the flickering or blurring and tap the slide bar.
The adjustment is completed.

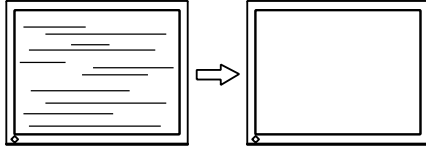

- **To correct screen position [Hor.Position/Ver.Position]**

Since the number of pixels and the pixel positions are fixed on the LCD monitor, only one position is provided to display images correctly. The position adjustment is made to shift an image to the correct position.

Settings	Screen status
Hor.Position	<p>When the screen position on the monitor is shifted horizontally, perform the screen position adjustment.</p>
Ver.Position	<p>When the screen position on the monitor is shifted vertically, perform the screen adjustment.</p>

(1) Choose the <Hor.Position>/<Ver.Position> icon in the <Screen> menu and tap the slide bar.
The <Hor.Position>/<Ver.Position> menu appears.

(2) Trace the slide bar left and right to adjust so that the whole display area, drawn by the dotted line frame, appears on the screen. Then tap the slide bar.

The adjustment is completed.

Attention

- The flickering or blurring may not be eliminated perfectly depending on your PC or graphics board.

NOTE

- When vertical bars appear on the screen after adjustment, go back to “To eliminate the vertical bars [Clock]” and perform again. (Clock → Phase → Position)

5 Adjust the color gradation.

- **To adjust color gradation automatically [Auto Range Adjust]**

Every color gradation (0 to 255) can be displayed by adjusting the signal output level.

- (1) Display Pattern 2 in full screen on the monitor using the “Screen Adjustment Utility” or the screen adjustment pattern files.

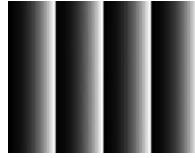

- (2) Choose the <Auto Range Adjust> icon in the <Screen> menu and tap the slide bar.
“Your current setting will be lost, if you perform “Auto Range Adjust”.
Do you continue?” appears on the screen.
- (3) Trace the slide bar left and right to select “Yes” and tap the slide bar.
Color gradation is adjusted automatically.
- (4) Close the Pattern 2. When using the “Screen Adjustment Utility”, close the program.

3-3 Color Adjustment

Simple Adjustment

- **To select the color mode [Color Mode]**

Changing the color mode enables you to set the monitor to the appropriate display mode.

[PC Input Signal]

An appropriate display mode is selectable out of five modes.

Modes	Status
Text	Suitable for displaying text for word processing or spreadsheets.
Picture	Suitable for displaying images such as photos or picture images.
Movie	Suitable for playing back animated images.
Custom (PCx*)	Available for making desired settings.
sRGB	Suitable for color matching with sRGB compatible peripherals.

* The input signal selected at that time is displayed.

[VIDEO Input Signal]

An appropriate display mode is selectable out of four modes.

Modes	Status
Standard	Standard video display.
Soft	Suitable for cinema effect, etc.
Dynamic	Suitable for a clearly outlined image.
Custom (VIDEOx*)	Available for making desired settings.

* The input signal selected at that time is displayed.

[Procedure]

- (1) Choose the <Color> icon in the Setting menu and tap the slide bar.
- (2) Choose the <Color Mode> icon in the <Color> menu and tap the slide bar.
The <Color Mode> menu appears.
- (3) Trace the slide bar left and right to select the desired mode and tap the slide bar.
The color mode setting is completed.

NOTE

- The adjustment status of the Color Mode may be changed. (Refer to “Advanced Adjustment” on [page 24](#).)

Advanced Adjustment

• To adjust/set Color Mode

Independent adjustments/settings and saving of the Color adjustment are available for each mode.

[PC Input Signal] ✓: Adjustment available –: Adjustment unavailable

Icon	Function	Color mode				
		Text	Picture	Movie	Custom (PCx*)	sRGB
	Brightness	✓	✓	✓	✓	✓
	Black Level	–	–	–	✓	–
	Contrast	–	✓	✓	✓	–
	Saturation	✓	✓	✓	✓	–
	Hue	✓	✓	✓	✓	–
	Temperature	✓	✓	✓	✓	–
Advanced Settings						
	OutlineEnhancer	–	✓	✓	✓	–
	ContrastEnhancer	–	✓	✓	✓	–
	Gain	–	–	–	✓	–
	Gamma	–	–	–	✓	–
	Reset	✓	✓	✓	✓	✓

[VIDEO Input Signal] ✓: Adjustment available –: Adjustment unavailable

Icon	Function	Color mode			
		Standard	Soft	Dynamic	Custom (VIDEOx*)
	Brightness	✓	✓	✓	✓
	Black Level	✓	✓	✓	✓
	Contrast	✓	✓	✓	✓
	Saturation	✓	✓	✓	✓
	Hue	✓	✓	✓	✓
	Temperature	✓	✓	✓	✓
Advanced Settings					
	OutlineEnhancer	✓	✓	✓	✓
	ContrastEnhancer	✓	✓	✓	✓
	Gamma	–	–	–	✓
	Noise Filter	–	–	–	✓
	I/P Conversion	–	–	–	✓
	Reset	✓	✓	✓	✓

* The input signal selected at that time is displayed.













Attention

- Perform [Auto Range Adjust] before starting color adjustment for analog input signals sent from a PC. Refer to “To adjust color gradation automatically” on [page 22](#).
- Wait 30 minutes or more from monitor power on before starting the color adjustment.
- Choose <Reset> in the <Color> menu to revert to the default settings (factory settings) of hue of the color mode selected.
- The same image may be seen in different colors on multiple monitors due to their monitor-specific characteristics. Make fine color adjustment visually when matching colors on multiple monitors.

NOTE

- The adjustment functions differ depending on the mode. For details, refer to the tables at left.

• **Adjustment items**

Menu	Description	Adjustment range
Brightness 	To adjust the full screen brightness as desired	0 to 100%
Black Level 	To adjust the black level as desired	0 to 100%
	NOTE	
	<ul style="list-style-type: none"> • RGB (Red, Green, Blue) is adjusted respectively for PC input signal, and RGB is adjusted together for VIDEO input signal. 	
Contrast 	To adjust the contrast of the image	0 to 100% Every color gradation can be displayed when setting to 50%.
Saturation 	To adjust color saturation	-50 to 50
	Attention	
	<ul style="list-style-type: none"> • This function may not display every color gradation. 	
Hue 	To produce a desired skin color, etc.	-50 to 50
	Attention	
	<ul style="list-style-type: none"> • This function may not display every color gradation. 	
Temperature 	To select the color temperature	4000K to 10000K, for every 500K as a unit. (Including 9300K)
	NOTE	
	<ul style="list-style-type: none"> • Setting the value to "Off" presents the natural color temperature of the panel. • The values shown in the Kelvin (K) are available only as reference. 	
OutlineEnhancer 	This emphasizes the outline of images by shading	-5 to 5
ContrastEnhancer 	This can change the feeling of contrast in the image	Enable/Disable
Gain 	To adjust red, green, and blue to a desired color tone respectively	0 to 100% Adjust the respective brightness of red/green/blue to make a desired color tone. Display an image with white or gray background for adjustment
Gamma 	To adjust the gamma value	1.8/2.0/2.2/2.4
	NOTE	
	<ul style="list-style-type: none"> • Digital input signal is recommended for gamma value setting. 	
Noise Filter 	To reduce a precise noise or a noise at MPEG compression	High/Low/Disable
	Attention	
	<ul style="list-style-type: none"> • The screen image may be degraded depending on the setting. 	
I/P Conversion 	To set the I/P (Interlace progressive) conversion's processing methods	Auto/Cinema/Moving Image/Still Image Select one of the above according to the screen image displayed on the monitor.
Reset 	To reset the color settings of the selected Color mode to the default settings	

NOTE

- The values shown in the "%" are available only as reference.

[Procedure]

- (1) Choose the <Color> icon in the Setting menu and tap the slide bar.
- (2) Choose the <Color Mode> icon in the <Color> menu and tap the slide bar.
- (3) Select the desired color mode in the <Color Mode> menu and tap the slide bar.
- (4) Select the desired function to adjust/set in the <Color> menu and tap the slide bar.
The selected function menu appears.
- (5) Trace the slide bar left and right to adjust/set the values and tap the slide bar.
The adjustment/settings are completed.

- **To adjust the brightness automatically [BrightRegulator]**

The screen brightness is automatically adjusted corresponding to both the brightness of the image and the environmental brightness detected by the sensor at the lower side of the monitor.

[Procedure]





- (1) Choose the <Monitor Settings> icon in the Setting menu and tap the slide bar.
- (2) Choose the <BrightRegulator> icon in the <Monitor Settings> menu and tap the slide bar.
The <BrightRegulator> menu appears.
- (3) Trace the slide bar left and right to select either “High”, “Standard” or “Disable” and tap the slide bar.
The BrightRegulator setting is completed.

NOTE

- Do not cover the sensor.
- Set to “High” if you feel a little brighter with “Standard” setting status.

3-4 Sound Adjustment

- To adjust [Volume/Treble/Bass/Balance/Sound Level].

Menu	Description	Adjustment range
Volume 	To adjust the volume	0 to 30
Treble 	To adjust the sound strengths/weaknesses in the high sound area	-15 to 15
Bass 	To adjust the sound strengths/weaknesses in the low sound area	-15 to 15
Balance 	To adjust the volume balance on left and right sides	-32 to 32
Sound Level 	To adjust the input sound level	-3 to 3

[Procedure]

- (1) Choose the <Sound> icon in the Setting menu and tap the slide bar.
- (2) Choose the desired function to adjust in the <Sound> menu and tap the slide bar.
The selected function menu appears.
- (3) Trace the slide bar left and right to adjust the value and tap the slide bar.
The adjustment is completed.

NOTE

- The sound adjustments other than [Sound Level] are available to perform for speakers and headphones respectively. When adjusting the headphone sound, connect the headphone to the monitor.
- The volume difference may occur depending on the kinds of input signals, since the average sound level of the external equipment differs. For example, if the volume difference of VIDEO 1 and VIDEO 2 input signals becomes large, you can reduce the volume difference between them by raising the [Sound Level] of the lower volume side.

NOTE

- The <Volume> menu can be displayed by tapping the slide bar when no menu is displayed on the screen.

Attention

- Depending on the volume setting, sound distortion may occur. In such a case, turn the volume down. The sound distortion may be diminished.

3-5 PinP (Picture in Picture) Display

- To display the PC input signal screen (Main Window) and the VIDEO input signal screen (Sub-Window) simultaneously [PinP]

When a PC and an AV equipment are connected to the monitor, the monitor allows you to display both screen images on the Main Window and the Sub-Window.

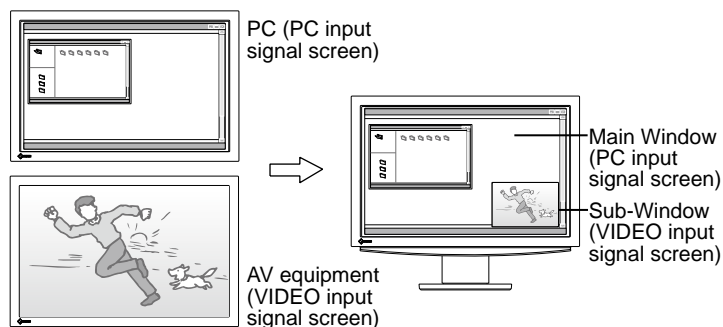

[Procedure]

- (1) Choose the <PinP Settings> icon in the Setting menu and tap the slide bar.
- (2) Choose the <PinP> icon in the <PinP Settings> menu and tap the slide bar.
The <PinP> menu appears.
- (3) Trace the slide bar left and right to select “On” and tap the slide bar.
The setting is completed.

■ To return to the normal display mode (Single display) from PinP display mode

[Procedure]

- (1) Choose the <PinP Settings> icon in the Setting menu and tap the slide bar.
- (2) Choose the <PinP> icon in the <PinP Settings> menu and tap the slide bar.
The <PinP> menu appears.
- (3) Trace the slide bar left and right to select “Off” and tap the slide bar.
The PinP display mode is canceled.

NOTE

- When the <PinP> is set to “On”, the monitor displays the images for the PC input signal currently selected and the VIDEO input signal previously selected in dual screen.
- In PinP display mode, both sounds for Main Window and Sub-Window are heard simultaneously.
The sound level of the Sub-Window effects on that of the Main Window.
- Touching INPUT for approx. two seconds enables you to change the display mode to PinP mode.
- Touching INPUT and using the Input Selection menu enables you to change the display mode to PinP mode. (Refer to [page 18.](#))

Attention

- When selecting the VIDEO input signal, the PinP function is not available.
- The Main Window is not used for VIDEO input signal display and the Sub-Window is not used for PC input signal display.

NOTE

- Touching INPUT for approx. two seconds in PinP display mode also allows you to return to the single display mode.

■ To switch the input signal for Main Window/Sub-Window

[Procedure]

- (1) Touch INPUT.

The Input Selection menu appears.

- (2) Trace the slide bar left and right to select <Main Window>/<Sub-Window> and tap the slide bar.

The Input Selection menu for <Main Window>/<Sub-Window> appears.

- (3) Trace the slide bar left and right to select the input signal and tap the slide bar.

The input signal is changed.

[Input selection for Main Window]
Ex.: PC 1→PC 2 for Main Window

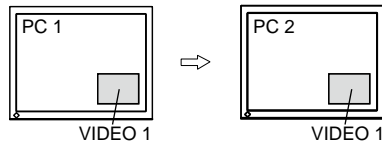

[Input selection for Sub-Window]
Ex.: VIDEO 1→VIDEO 2 for Sub-Window

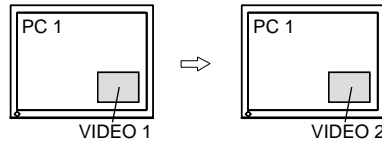

■ To hide the Sub-Window display with its sound being heard

[Sub-Window Off]

In PinP display mode, this function allows you to hide the Sub-Window display with its sound heard.

If you want to show the PC screen display temporarily, this function is available.

[Procedure]

- (1) Touch INPUT.

The Input Selection menu appears.

- (2) Trace the slide bar left and right to select “Sub-Window Off” and tap the slide bar.

Only the Sub-Window display disappears temporarily.

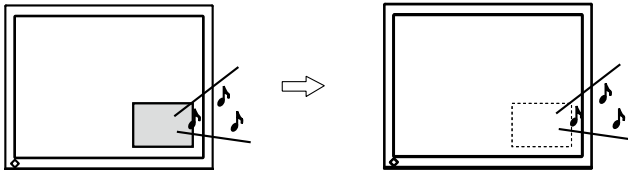

Attention

- The setting items of the Input Selection menu in PinP display mode is different from those in the single display mode.
- When changing the Main Window input signal (PC input signal), [USB] setting should be changed. (Refer to page 18.)

NOTE

- Touch INPUT to display the Sub-Window display again.

- **To change the Sub-Window position [Sub-Window Position]**

You can select the Sub-Window position either “Upper Left”, “Upper Right”, “Lower Left” and “Lower Right”.

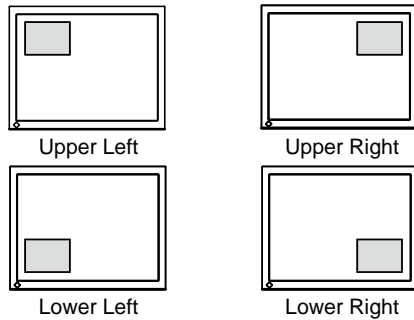

[Procedure]

- (1) Choose the <PinP Settings> icon in the Setting menu and tap the slide bar.
- (2) Choose the <Sub-Window Position> icon in the <PinP Settings> menu and tap the slide bar.
The <Sub-Window Position> menu appears.
- (3) Trace the slide bar left and right to select either “Upper Left”, “Upper Right”, “Lower Left” or “Lower Right” and tap the slide bar.
The Sub-Window position setting is completed.

- **To set the translucent level for Sub-Window [Translucent]**

In PinP display mode, the Sub-Window is available to set in translucent. So you can see the Main Window through the Sub-Window.

[Procedure]

- (1) Choose the <PinP Settings> icon in the Setting menu and tap the slide bar.
- (2) Choose the <Translucent> icon in the <PinP Settings> menu and tap the slide bar.
The <Translucent> menu appears.
- (3) Trace the slide bar left and right to select either “0”, “1”, “2” and “3” and tap the slide bar.
The translucent setting is completed.

- **To select the Sub-Window display size [Sub-Window Size]**

The Sub-Window display size is automatically changed according to the aspect information from the input signal of an AV equipment (Auto Screen Size). However, the Sub-Window display size may be changed manually in the <Sub-Window Size> menu.

[Procedure]

- (1) Choose the <PinP Settings> icon in the Setting menu and tap the slide bar.
- (2) Select the <Sub-Window Size> icon in the <PinP Settings> menu and tap the slide bar.
The <Sub-Window Size> menu appears.
- (3) Trace the slide bar left and right to select either “4:3” and “16:9”, and tap the slide bar.
The Sub-Window size setting is completed.

NOTE

- If you set the translucent setting to “0”, the Sub-Window is not transparent at all. (The transparency is as shown below. “0”: 0%, “1”: 25%, “2”: 50%, “3”: 75%)

Attention

- When using 1080i/720p/1080p input signal, the display size of the Sub-Window display is fixed to 16:9.

NOTE

- If you do not want to change the Sub-Window size automatically, set the <Auto Screen Size> in the <Monitor Settings> to “Disable”.

3-6 Screen Size Changing

- To change the screen image/projected image size appearing on the screen [Screen Size]

[PC Input Signal]

If you set the resolution other than recommended resolution on the monitor, the monitor shows the image automatically enlarged on the whole screen. The <Screen Size> menu allows you to change the screen display size.

Settings	Status
Full Screen	Displays an image in full screen. Images are distorted in some cases because the vertical rate is not equal to the horizontal rate.
Enlarged	Displays an image in full screen. In some cases, a blank horizontal or vertical border appears to equalize the vertical rate and the horizontal rate.
Normal	Displays images with the specified resolution.

Ex.: 1280 × 1024 display

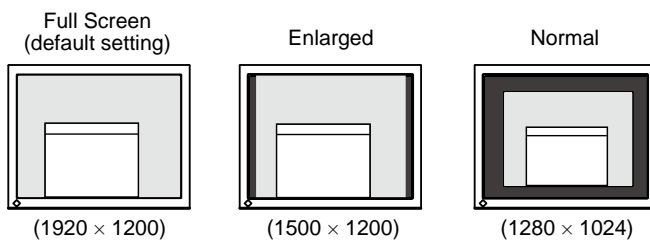

[Procedure]

- (1) Choose the <Screen Size> icon in the Setting menu and tap the slide bar.
The <Screen Size> menu appears.
- (2) Trace the slide bar left and right to select either “Full Screen”, “Enlarged”, or “Normal” and tap the slide bar.
The screen size setting is completed.

[VIDEO Input Signal]

The screen display size is automatically changed according to the aspect information from the input signal of an AV equipment (Auto Screen Size). However, the screen size may be changed manually in the <Screen Size> menu.

Settings	Status
4:3	Displays the image in 4:3 size. The borders are shown on both sides of the screen. 16:9 sized images from the input signal are compressed horizontally and spread vertically.
Letterbox	The black borders on the upper and lower sides of the image are cut and the images are displayed on the whole screen. Except for Letterbox, the upper and lower parts of the projected image are cut.
16:9	Displays the image in 16:9 size with the left and right parts of the projected image slightly cut off. In this mode, 4:3 sized image from the input signal are slightly compressed vertically and spread horizontally.
16:9 Full	Displays the entire image in 16:9 size on the whole screen without cutting any part. The borders appear on the top and bottom sides of the screen. (Selectable only when receiving 1080i/720p/1080p input signal)

NOTE

- If you do not want to change the screen display size automatically, set the <Auto Screen Size> in the <Monitor Settings> menu to “Disable”.

The screen sizes and kinds are shown below.

The available setting value differs depending on the input signal.

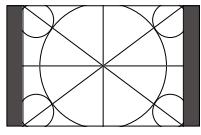
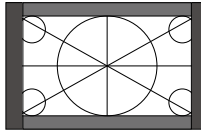
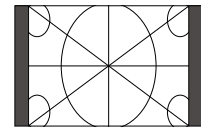
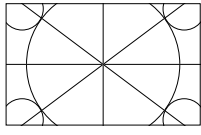
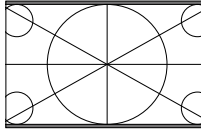
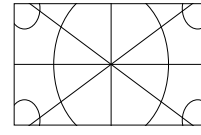
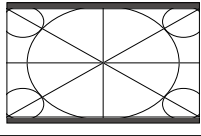
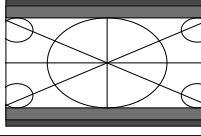
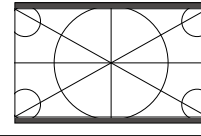
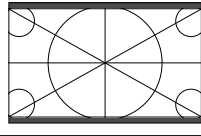
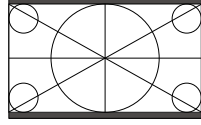
Input signal:Aspect ratio (Format) Screen size	4:3 (480i/480p/ 576i/576p)	Letterbox* (480i/480p/ 576i/576p)	16:9	
			(480i/480p/ 576i/576p)	(1080i/720p/1080p)
4:3				-
Letterbox				-
16:9				
16:9 Full	-	-	-	

* Letterbox shows a 4:3 screen display keeping the vertical and horizontal ratio of 16:9.

[Procedure]

- (1) Choose the <Screen Size> icon in the Setting menu and tap the slide bar.
The <Screen Size> menu appears.
- (2) Trace the slide bar left and right to select either “4:3”, “Letterbox”, “16:9” or “16:9 Full” and tap the slide bar.
The screen size setting is completed.

NOTE

- Select “16:9” when the noise appears around the peripheral portions of the screen image with “16:9 Full” selected.

3-7 Off Timer Setting

- To set monitor power-off time [Off Timer]

This function allows the monitor to automatically turn off after a specified time has passed.

[Procedure]

- (1) Choose the <Off Timer> icon in the Setting menu and tap the slide bar.
The <Off Timer> menu appears.
- (2) Trace the slide bar left and right to set the monitor power-off time in 15 minutes increments (15 to 180 minutes) and tap the slide bar.
The setting is completed.

[Checking/Changing the remaining power-off time]

- (1) Choose the <Off Timer> icon in the Setting menu and tap the slide bar.
The current remaining time is displayed.
- (2) When changing the remaining power-off time, while the remaining time is displayed, trace the slide bar left and right to change the remaining time.
Then tap the slide bar.

3-8 Monitor Power-saving Mode Setting

- To set the resume conditions from the power-saving mode [Signal Detection]

This function sets the power-saving mode condition when no input signal is detected on the current selected input signal and the resume conditions from the power-saving mode.

Settings	No input signal	Resume conditions from power-saving mode
All Input Signals	After 5 seconds have passed with no input signal detected, the monitor enters the power-saving mode.	All input signals are watched and if any signal is detected in the no-signal status, the monitor resumes to display the projected image with the detected input signal.
Current Input Signal		The signal selected when entering the power-saving mode is watched and if any signal is detected in no signal status, the monitor resumes to display the projected image with the current input signal selected.
Disable	After 45 seconds with no input signal status, the monitor enters power off status.	

[Procedure]

- (1) Choose the <Monitor Settings> icon in the Setting menu and tap the slide bar.
- (2) Choose the <Signal Detection > icon in the <Monitor Settings> menu and tap the slide bar.
The <Signal Detection > menu appears.
- (3) Trace the slide bar left and right to select either “All Input Signals”, “Current Input Signal” or “Disable” and tap the slide bar.
The signal detection setting is completed.

Attention

- “The power will turn off soon. To cancel Off Timer, touch the slide bar.” appears on the screen one minutes before the monitor turns off.

NOTE

- If it is set to “Disable”, the off-timer setting is released.

Attention

- The monitor watches the input signal status. If the input signal is detected before entering the power-saving mode, the signal detection is not recognized as a resume condition.
- When displayed in PinP, the monitor does not shift to power-saving mode.
- If it is set to “All Input Signals”, the monitor may not resume from the power-saving mode depending on the connected external equipments or some conditions. When the monitor does not resume, change the setting or touch the slide bar and then select the input signal for the desired image sent from the equipment.

Attention

- Unplugging the power cord completely shuts off power supply to the monitor.
- Even if the monitor enters the sleep mode, all the devices connected to the USB ports (upstream and downstream) work.
(Therefore the monitor power consumption varies with connected devices even in the power-saving mode.)

3-9 Power Indicator/EIZO Logo Display Setting

• To turn off the power indicator while a screen is displayed [Power Indicator]

This function enables you to turn off the Power indicator (blue) while a screen is displayed.



[Procedure]

- (1) Choose the <Monitor Settings> icon in the Setting menu and tap the slide bar.
- (2) Choose the <Power Indicator> icon in the <Monitor Settings> menu and tap the slide bar.
The <Power Indicator> menu appears.
- (3) Trace the slide bar left and right to select “Off” and tap the slide bar.
The power indicator setting is completed.



• To set EIZO logo display/no EIZO logo display when the monitor turns on [EIZO Logo Appearing Function]

When the unit is turned on, the EIZO logo appears at the center of the screen. This function enables you to select Logo display/No logo display.

[Setting Methods]

- (1) Touch  to turn off the monitor.
- (2) Touch  for approx. three seconds.
The EIZO logo does not appear on the screen.

[Resetting]

- (1) Touch  to turn off the monitor.
- (2) Touch  for approx. three seconds.
The logo appears again.

3-10 Beeper Setting

• To set the beeper [Beep]

Set the beeper on/off for operation tone of the switches, connection error, etc.

Sound type	Status
Short beep	<ul style="list-style-type: none"> • Sounds whenever a basic switch operation is performed.
Long beep	<ul style="list-style-type: none"> • Sounds when “On” or “Off” in the operation lock function is selected. • Sounds when “On” or “Off” in the EIZO logo appearing function is selected. • Sounds when “On” or “Off” in PinP display function is selected by touching INPUT for approx. two seconds. • Sounds when the setting and/or adjustment value is decided by the slide bar.
Consecutive beeps	<ul style="list-style-type: none"> • Sounds when the monitor is not connected correctly. • Sounds when a PC or an AV equipment does not turn on. • Sounds when the signal frequency beyond specification is received.

NOTE

- The Power indicator lights up at power on with the default setting.

NOTE

- The logo appears with the default setting.

[Procedure]

- (1) Choose the <Monitor Settings> icon in the Setting menu and tap the slide bar.
- (2) Choose the <Beep> icon in the <Monitor Settings> menu and tap the slide bar.
The <Beep> menu appears.
- (3) Trace the slide bar left and right to select either “On” or “Off” and tap the slide bar.
The beep setting is completed.

3-11 Information Checking

• To check settings, usage time, etc. [Information]

This function allows you to check settings, model name, serial number, and usage time of the monitor.

- (1) Choose the <Information> icon in the Setting menu and tap the slide bar.
The <Information> menu appears.
- (2) Tap the slide bar to check the settings, etc.

3-12 Language Setting to be displayed

• To set the language displayed in the menu [Language]

This function enables you to select the Setting menu language.

Selectable languages

English/German/French/Spanish/Italian/Swedish/Japanese/Simplified Chinese/
Traditional Chinese

[Procedure]

- (1) Choose the <Monitor Settings> icon in the Setting menu and tap the slide bar.
- (2) Choose the <Language> icon in the <Monitor Settings> menu and tap the slide bar.
The <Language> menu appears.
- (3) Trace the slide bar left and right to select the language and tap the slide bar.
The language setting is completed.

NOTE

- The usage time is not always “0” when you purchase the monitor due to factory inspection.

Chapter 4 Troubleshooting

If a problem still remains after applying the suggested remedies, contact your local dealer.

- No picture problems→See No. 1 and 2 in [PC Input Signal], No. 1 and 2 in [VIDEO Input Signal]
- Imaging problems→See No. 1 - 6 in [Common], No. 3 - 7 in [PC Input Signal], No.3 in [VIDEO Input Signal]
- Other problems→See No. 7 - 11 in [Common], No. 8 in [PC Input Signal], No. 4 and 5 in [VIDEO Input Signal]
- USB problems→See No. 9 in [PC Input Signal]

[Common]

Problems	Possible cause and remedy
1. The screen is too bright or too dark.	<ul style="list-style-type: none"> • Adjust <Brightness> or <Contrast> from the <Color> menu. (The LCD monitor backlight has a fixed life span. When the screen becomes dark or begins to flicker, contact your local dealer.)
2. Afterimages appear.	<ul style="list-style-type: none"> • Use a screen saver or off timer function for a long-time image display. • Afterimages are particular to LCD monitors. Avoid displaying the same image for a long time.
3. Green/red/blue/white dots or defective dots remain on the screen.	<ul style="list-style-type: none"> • This is due to LCD panel characteristics and is not a failure.
4. Interference patterns or fingerprints remain on the screen.	<ul style="list-style-type: none"> • Leave the monitor with a white screen. The symptom may disappear.
5. Noise appears on the screen.	<ul style="list-style-type: none"> • When utilizing [ContrastEnhancer] and/or [OutlineEnhancer] function, the normal images may not be displayed since the display gradation abnormality or noise may occur on the screen depending on the display pattern.
6. Characters are pigmented.	<ul style="list-style-type: none"> • When [OutlineEnhancer] is set excessively, the characters on the screen may be affected by color.
7. No sound/Volume control is not available.	<ul style="list-style-type: none"> • Check whether the audio cable is connected properly. • Check whether a headphone is connected to the headphone jack. • Adjust the sound volume. (Refer to page 27.)
8. Sound volume varies depending on the equipment connected.	<ul style="list-style-type: none"> • Adjust the volume difference between the equipment connected by the <Sound Level> in the <Sound> menu. (Refer to page 27.)
9. The monitor turns off suddenly.	<ul style="list-style-type: none"> • Check whether the [Off Timer] function is set. Check the [Off Timer] setting. (Refer to page 33.) • Check whether "Disable" is set in the <Signal Detection> of the <Monitor Settings> menu. (Refer to page 33.)
10. Unselectable menu items	<ul style="list-style-type: none"> • The selectable menu items differ depending on the input signal. Please check the Setting menu list. (Refer to "Setting menu list" on page 44.)
11. Switches do not operate.	<ul style="list-style-type: none"> • Check whether the switches are locked. (Refer to page 17.)

[PC Input Signal]

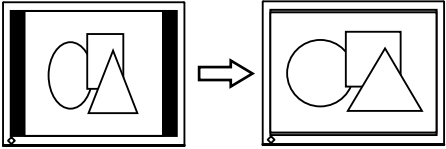
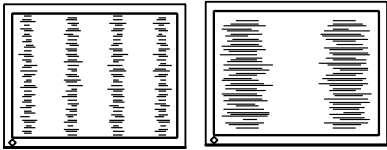
Problems	Possible cause and remedy
<p>1. No Picture</p> <ul style="list-style-type: none"> Power indicator does not light up. Power indicator lights in orange. Power indicator lights in blue. 	<ul style="list-style-type: none"> Check whether the power cord is correctly connected. Touch . Switch the input signal with INPUT. Press a key on the keyboard or click the mouse. Turn on the PC. Check whether the PC is properly connected to the monitor. Check the gain setting.
<p>2. The message below appears.</p> <ul style="list-style-type: none"> The message below shows that the input signal is out of the specified frequency range. (Such signal frequency is displayed in red.) Example: <div data-bbox="320 689 627 891" style="border: 1px solid black; padding: 5px; text-align: center;"> <p>PC 1</p> <p>Signal Error</p> <p>fD: 162.0MHz</p> <p>fH: 75.0kHz</p> <p>fV: 60.0 Hz</p> </div>	<p>These messages appear when the input signal is incorrect even if the monitor is functioning.</p> <ul style="list-style-type: none"> Change the mode appropriately using the graphics board's utility software. Refer to the manual of the graphics board for details.
<p>3. The image is not displayed in correct resolution even if Auto Screen Adjust is performed.</p> <ul style="list-style-type: none"> The resolution of the input signal is not recognized correctly and the image is displayed shrunk or distorted. <div data-bbox="252 1064 699 1211" style="text-align: center;">  </div>	<ul style="list-style-type: none"> Adjust <Resolution> from the <Screen> menu so that the input signal resolution equals the resolution in the <Resolution> menu. If the resolution is set, the [Auto Screen Adjust] is performed again automatically.
<p>4. The screen position is shifted.</p> <div data-bbox="384 1261 568 1406" style="border: 1px solid black; width: 100px; height: 60px; margin: 0 auto;"></div>	<ul style="list-style-type: none"> Adjust <Hor.Position/Ver.Position> from the <Screen> menu. (Refer to page 21.) If the problem persists, use the graphics board's utility software if available to change the display position.
<p>5. Vertical bars appear on the screen or a part of the image is flickering.</p> <div data-bbox="280 1489 668 1637" style="text-align: center;">  </div>	<ul style="list-style-type: none"> Adjust <Clock> from the <Screen> menu. (Refer to page 20.) When the resolution is set to 1920 x 1200, the symptom may not be improved depending on the input signal used even if the [Clock] adjustment is performed. In this case, change the resolution to 1600 x 1200, 1920 x 1080, etc.
<p>6. Whole screen is flickering or blurring.</p> <div data-bbox="384 1688 568 1834" style="border: 1px solid black; width: 100px; height: 60px; margin: 0 auto;"></div>	<ul style="list-style-type: none"> Adjust <Phase> from the <Screen> menu. (Refer to page 21.)
<p>7. Noise appears on the screen.</p>	<ul style="list-style-type: none"> When entering the signals of analog input, change the setting in <Signal Filter> from the <Screen> menu. The symptom may not be improved depending on the input signal used. It is recommended that you switch the analog input signal to digital. When receiving HDCP signals, the normal images may not be displayed immediately.

Problems	Possible cause and remedy
8. No sound/Volume control is not available.	<ul style="list-style-type: none"> • Check whether the [USB] setting is corresponding to the input signal from the PC.
9. The USB devices connected to the monitor do not work.	<ul style="list-style-type: none"> • Check whether the USB cable is connected correctly. • Check whether the [USB] setting is in conformance with the input signal sent from the PC. (Refer to page 18.) • Change the USB port to another one (downstream port). If the PC or peripheral devices work correctly by changing the USB port, contact your local dealer. (Refer to the manual of the PC for details.) • Please perform the following to check the status. <ul style="list-style-type: none"> - Reboot the PC. - Connect the PC and peripheral devices directly. - If the PC or peripheral devices work correctly without connecting via the monitor (working as a USB hub), please contact your local dealer. • Check whether the PC and OS are USB compliant. (For USB compliance of the respective devices, consult their manufacturers.) • Check the PC's BIOS setting for USB when using Windows. (Refer to the manual of the PC for detail.)

[VIDEO Input Signal]

Problems	Possible cause and remedy
<p>1. No Picture</p> <ul style="list-style-type: none"> Power indicator does not light up. Power indicator lights in orange. Power indicator lights in blue. 	<ul style="list-style-type: none"> Check whether the power cord is correctly connected. Touch . Switch the input signal with INPUT. Turn on the AV equipment. Check whether the AV equipment is properly connected to the monitor. <p>[For VIDEO 1/VIDEO 2 input signal]</p> <ul style="list-style-type: none"> Switch the setting using the <Field Rate> in the <Monitor Settings>.
<p>2. The message below appears.</p> <ul style="list-style-type: none"> The frequency of the signal is outside the specification. Example: <div data-bbox="323 663 627 864" style="border: 1px solid black; padding: 10px; text-align: center; margin: 10px auto; width: fit-content;"> <p>VIDEO 1 Signal Error</p> </div>	<p>These messages appear when the input signal is incorrect even if the monitor is functioning.</p> <p>[For VIDEO 1/VIDEO 2 input signal]</p> <ul style="list-style-type: none"> Confirm the digital signal format by referring to the instruction manual of the equipment connected. (Refer to page 42.)
<p>3. The color shown on the display is not correct.</p>	<p>[For VIDEO 1/VIDEO 2 input signal]</p> <ul style="list-style-type: none"> Change the color space of the video input signal using <Color Space> in the <Monitor Settings> menu. (Normally, select "Auto".)
<p>4. The video images are out of control by the FF/REW operation when a video equipment is connected to the monitor.</p>	<ul style="list-style-type: none"> The monitor mechanism causes the image out of control status a little. This is not a malfunction.
<p>5. No sound/Volume control is not available.</p>	<p>[For VIDEO 1/VIDEO 2 input signal]</p> <ul style="list-style-type: none"> Check whether the applicable format of the equipment connected is correct. Refer to page 42 for the sound input format of the monitor.

• Messages List

The meanings of the main messages appearing on the screen are described below.

Messages	Description
"Your current setting will be lost, if you perform "Auto Screen Adjust". Do you continue?"	Appears when performing [Auto Screen Adjust].
"Your current setting will be lost, if you perform "Auto Range Adjust". Do you continue?"	Appears when performing [Auto Range Adjust].
"Your current color data will be lost."	Appears when performing <Reset> in the <Color> menu. Returns the color mode setting currently selected to the default settings.
"If the field rate is changed, no picture may be displayed on screen. Do you change the setting?"	Appears when changing the settings of [Field Rate].
"If the USB setting is changed, the USB connection to the selected PC will be lost. Do you change the setting?"	Appears when changing the settings of [USB]. <ul style="list-style-type: none"> Do not change the settings in the following cases. <ul style="list-style-type: none"> When connecting a memory device such as a USB memory to the monitor The data may be lost and damaged. Be sure to change the USB setting after removing the memory device. When an application such as a sound playback, etc. works The sound may not output if the setting is returned to the original. Be sure to change the USB setting after exiting from the application.
"The power will turn off soon. To cancel Off Timer, touch the slide bar."	Appears on the display from one minute before the power turns off to the power-off time when the Off Timer is set. Touching the slide bar while the message appears will release the Off Timer setting and the message disappears.
"All settings except for the field rate and USB are reset."	Appears when performing [Reset] in the Setting menu. Set all the settings except for [Field Rate], [USB] and [Volume] to the default settings.
"Volume adjust does not support this sound signal." (for VIDEO 1/VIDEO 2 input signal)	Appears when selecting <Volume> menu or performing the shortcut menu of the volume while receiving the sound signal not corresponding to the monitor. In this case, no sound is output.

Chapter 5 Reference

5-1 Attaching an Arm

The stand can be removed and replaced with an arm (or another stand) to be attached to the monitor. Use an arm or stand of EIZO option.

[Attaching]

1 Lay the LCD monitor on a soft cloth spread over on a stable surface with the panel surface facing down.

2 Remove the stand. (Prepare a screwdriver.)

Unscrew the four screws securing the unit and the stand with the screwdriver.

3 Attach the monitor to the arm or stand.

Secure the monitor to the arm or stand using the screws specified in the user's manual of the arm or stand.

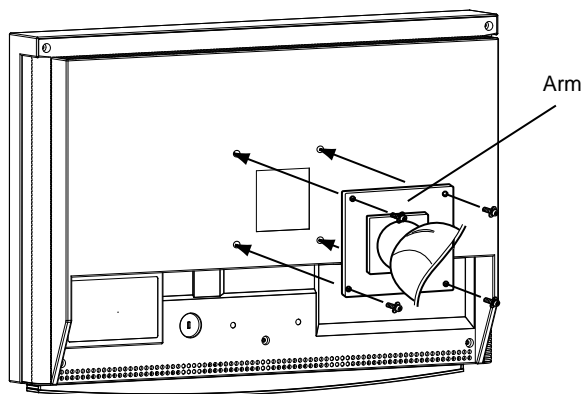

Attention

- When attaching an arm or stand, follow the instructions of their user's manual.
- When using another manufacturer's arm or stand, confirm the following in advance and select one conforming to the VESA standard. Use M4 × 12 mm screws supplied with this monitor.
 - Clearance between the screw holes: 100 mm × 100 mm
 - Thickness of plate: 2.6 mm
 - Strong enough to support weight of the monitor unit (except the stand) and attachments such as cables.
- Attach an arm or stand to meet the following tilt angles of the monitor. Do not use the monitor with the tilt angle beyond the values shown below.
 - Upper: 60° Lower: 45°
- Do not turn the monitor lengthwise.
- Connect the cables after attaching an arm.

5-2 Specifications

Panel	LCD Panel	24.1-inch (610 mm) TFT color LCD with anti-glare hard coating Viewing angle: Vertical 178°, Horizontal 178° (CR: 10 or more)		
	Dot Pitch	0.270 mm		
	Resolution	1920 dots × 1200 lines		
	Max. Display Color	Approx. 16.77 million colors: Applicable to 8 bit (1064.33 million colors/10 bit-LUT)		
	Display Area (H × V)	518.4 mm × 324.0 mm		
PC Input Signal	Digital Input Signal (PC 1)	Input Signal Connector	DVI-D × 1	
		Horizontal Scan Frequency	31.5 ~ 76 kHz: each preset signal ±1 kHz	
		Vertical Scan Frequency	59 ~ 61 Hz: each preset signal ±1 Hz (VGA TEXT: 69 ~ 71 Hz) (49 ~ 51 Hz is also available@720p/1080p*1)	
		Max. Dot Clock	162 MHz	
		Signal Transmission System	TMDS (Single Link)	
	Analog Input Signal (PC 2)	Input Signal Connector	D-Sub mini 15-pin × 1	
		Horizontal Scan Frequency	31.5 ~ 80 kHz: each preset signal ±1 kHz	
		Vertical Scan Frequency	55 ~ 76 Hz: each preset signal ±1 Hz (49 ~ 51 Hz is also available@720p/1080p*1)	
		Max. Dot Clock	162 MHz	
		Input Signal (Sync)	Separate, TTL, positive/negative	
		Input Signal (Video)	Analog, positive (0.7Vp-p/75Ω)	
		Video Signal Memory	50 (preset: 34)	
	Audio Input	USB communication		
	Plug and Play	VESA DDC2B		
	VIDEO Input Signal	HDMI Input Signal*2 (VIDEO 1/2)	Input Signal Connector	HDMI Type A × 2
Applicable Format			Video signal - 525i (480i)/525p (480p)/1125i (1080i)/750p (720p)/1125p (1080p): 60 Hz - 625i (576i)/625p (576p)/1125i (1080i)/750p (720p)/1125p (1080p): 50 Hz Audio signal - 2ch linear PCM (32 kHz/44.1 kHz/48 kHz/88.2 kHz/96 kHz/176.4 kHz/192 kHz)	
S-Video/Audio Input Signal (VIDEO 3)		Input Signal Connector	Video: DIN mini 4 pin × 1 Audio: Pin jack × 1 (Common with Composite Video input)	
		Input Signal Level (Video)	Y: 1.0Vp-p/75Ω, C: 0.28Vp-p/75Ω	
Composite Video/Audio Input Signal (VIDEO 3)		Input Signal Connector	Video: Pin jack × 1 Audio: Pin jack × 1 (Common with S-Video input)	
		Input Signal Level (Video)	1.0Vp-p/75Ω	
Component Video/Audio Input Signal (VIDEO 4)		Input Signal Connector	Video: D terminal × 1 Audio: Pin jack × 1	
		Applicable Format (Video)	[D4] - 525i (480i)/525p (480p)/1125i (1080i)/750p (720p): 60 Hz	
		Input Signal Level (Video)	Y: 1.0Vp-p/75Ω, Cb,Cr: 0.7Vp-p/75Ω	

Audio Output	Audio Output Terminal	Ø3.5 stereo mini jack × 1
	Headphone Jack	Ø3.5 stereo mini jack × 1
USB	Standard	USB Specification Revision 2.0
	Port	Upstream port × 2, Downstream port × 2
Classification of Equipment		Type of protection against electric shock: Class I EMC class: EN60601-1-2: 2001 Group 1 Class B Classification of medical device (MDD 93/42/EEC): Class I
Power Supply		100 - 120 VAC ±10%, 50/60Hz, 1.1 A - 0.7 A 200 - 240 VAC ±10%, 50/60Hz, 0.55 A - 0.4 A
Power Consumption	Screen Display On	110 W or less (with USB load) 100 W or less (normal mode) (without USB load)
	Power-saving mode	<ul style="list-style-type: none"> When <Signal Detection> setting is set to "All Input Signals": 7 W or less (at no input signal, without USB load) When <Signal Detection> setting is set to "Current Input Signal": 2 W or less (at PC input signal selection, at no input signal, without USB load)
	Power switch Off	1 W or less
Dimensions	Main unit	566 mm (22.3") (W) × 362.5 ~ 480 mm (14.3 ~ 18.9") (H) × 230 mm (9.1") (D)
	without Stand	566 mm (22.3") (W) × 396 mm (15.6") (H) × 92.3 mm (3.6") (D)
Weight	Main unit	approx. 10.3 kg (22.7 lbs)
	without Stand	approx. 7.9 kg (17.4 lbs)
Environmental Conditions	Temperature	Operating temperature: 0 °C ~ 35 °C (32 °F ~ 95 °F) Storage temperature: - 20 °C ~ 60 °C (- 4 °F ~ 140 °F)
	Humidity	Operating humidity: 30% to 80% R.H. (no condensation) Storage humidity: 30% to 80% R.H. (no condensation)
	Pressure	Operating: 700 hPa to 1,060 hPa Storage: 200 hPa to 1,060 hPa

*1 For some AV equipment such as Microsoft Xbox 360

*2 The monitor is not in compliance with the input signal from a PC and CEC (Consumer Electronics Control). The monitor is not applicable to the xvYCC standard for the color space.

Outside Dimensions

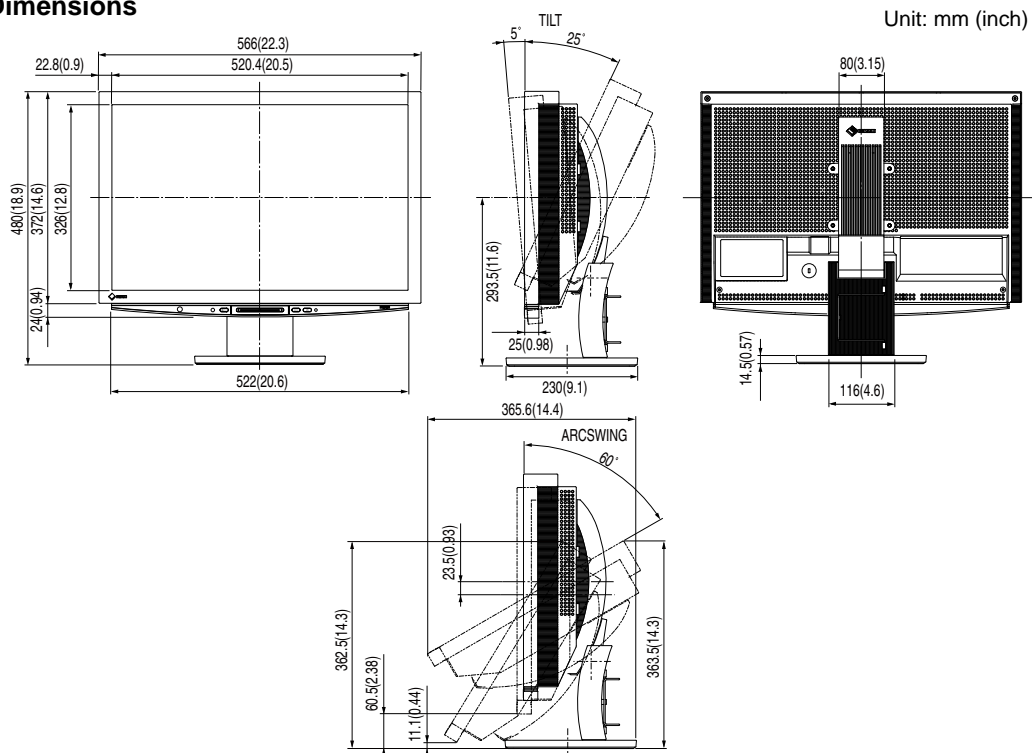

Setting menu list

Item		PC 1	PC 2	VIDEO 1	VIDEO 2	VIDEO 3	VIDEO 4	PinP	
Screen	Auto Screen Adjust	-	√	-	-	-	-	√*	
	Auto Range Adjust	-	√	-	-	-	-	√*	
	Clock	-	√	-	-	-	-	√*	
	Phase	-	√	-	-	-	-	√*	
	Hor.Position	-	√	-	-	-	-	√*	
	Ver.Position	-	√	-	-	-	-	√*	
	Resolution	-	√	-	-	-	-	√*	
	Signal Filter	-	√	-	-	-	-	√*	
Color	Color Mode	√	√	√	√	√	√	√	
	Brightness	√	√	√	√	√	√	√	
	Black Level	√	√	√	√	√	√	√	
	Contrast	√	√	√	√	√	√	√	
	Saturation	√	√	√	√	√	√	√	
	Hue	√	√	√	√	√	√	√	
	Temperature	√	√	√	√	√	√	√	
	Advanced Settings	OutlineEnhancer	√	√	√	√	√	√	√
		ContrastEnhancer	√	√	√	√	√	√	√
		Gain	√	√	-	-	-	-	√
		Gamma	√	√	√	√	√	√	√
Noise Filter		-	-	√	√	√	√	-	
I/P Conversion	-	-	√	√	√	√	-		
Reset	√	√	√	√	√	√	√		
Sound	Volume	√	√	√	√	√	√	√	
	Treble	√	√	√	√	√	√	√	
	Bass	√	√	√	√	√	√	√	
	Balance	√	√	√	√	√	√	√	
	Sound Level	-	-	√	√	√	√	-	
PinP Settings	PinP	√	√	-	-	-	-	√	
	Sub-Window Position	-	-	-	-	-	-	√	
	Translucent	-	-	-	-	-	-	√	
	Sub-Window Size	-	-	-	-	-	-	√	
Monitor Settings	Language	√	√	√	√	√	√	√	
	BrightRegulator	√	√	√	√	√	√	√	
	Signal Detection	√	√	√	√	√	√	√	
	Power Indicator	√	√	√	√	√	√	√	
	Beep	√	√	√	√	√	√	√	
	Auto Screen Size	-	-	√	√	√	√	-	
	Color Space	-	-	√	√	-	-	-	
	Field Rate	-	-	√	√	-	-	-	
USB	√	√	√	√	√	√	√		
Screen Size	√	√	√	√	√	√	√		
Off Timer	√	√	√	√	√	√	√		
Information	√	√	√	√	√	√	√		
Reset	√	√	√	√	√	√	√		

* When the Main Window uses PC 2 at PinP display

Main default settings (factory settings)

		PC Input Signal	VIDEO Input Signal	
			VIDEO 1/2	VIDEO 3/4
Color Mode		Custom		
Volume	Speaker	30		
	Headphone	10		
PinP		Off	-	
Language		English		
BrightRegulator		Standard		
Signal Detection		Current Input Signal		
Power Indicator		On		
Beep		On		
Auto Screen Size		-	Enable	
Color Space		-	Auto	-
USB		PC 1		
Screen Size		Full Screen	[480i/480p/576i/576p signal] 4:3 [1080i/720p/1080p signal] 16:9 Full	
Off Timer		Disable		

Option list

Panel Protector	EIZO "FP-2400W"
Cleaning Kit	EIZO "ScreenCleaner"
Arm	EIZO "LA-011-W" (wall mount arm [1-axis])
	EIZO "LA-030-W" (wall mount arm [3-axes])
	EIZO "LA-131-D" (flexible arm [3-axes])
Attachment	EIZO "QM-1"

5-3 Glossary

Clock

The analog input monitor needs to reproduce a clock of the same frequency as the dot clock of the graphics system in use, when the analog input signal is converted to a digital signal for image display.

This is called clock adjustment. If the clock pulse is not set correctly, some vertical bars appear on the screen.

Color Space

Color space is a method to specify and express the color. There are YUV and RGB, etc. YUV expresses the color by using the luminance (Y), the color difference of R (U) and the color difference of blue (V). RGB does it by using the gradation of 3 colors of Red (R), Green (G) and Blue (B).

ContrastEnhancer

ContrastEnhancer functions to reproduce images with a taste of contrast by compensating the gamma value as well as controlling the backlight brightness and the gain level according to the image status.

DVI (Digital Visual Interface)

DVI is a digital interface standard. DVI allows direct transmission of the PC's digital data without loss.

This adopts the TMDS transmission system and DVI connectors. There are two types of DVI connectors. One is a DVI-D connector for digital input signal only. The other is a DVI-I connector for both digital and analog input signals. The monitor is not applicable to the DVI-I input signal.

Field Rate

This is the number of times the monitor screen is redrawn in 1 second. The number of times differs depending on the Video standard.

Gain

This is used to adjust each color parameter for red, green and blue. An LCD monitor displays the color by the light passing through the panel color filter. Red, green and blue are the three primary colors. All the colors on the screen are displayed by combining these three colors. The color tone can be changed by adjusting the light intensity (volume) passing through each color's filter.

Gamma

Generally, the monitor brightness varies nonlinearly with the input signal level, which is called "Gamma Characteristic". A small gamma value produces a low-contrast image, while a large gamma value produces a high-contrast image.

HDCP (High-bandwidth Digital Contents Protection)

Digital signal coding system developed to copy-protect the digital contents, such as video, music, etc. This helps to transmit the digital contents safely by coding the digital contents sent via DVI terminal on the output side and decoding them on the input side.

Digital content cannot be reproduced if both the devices on the output and input sides are not applicable to the HDCP system.

HDMI (High-Definition Multimedia Interface)

HDMI is a digital interface standard, developed for consumer electrical appliance or AV equipment. This standard is issued on the basis of the DVI standard which is one of an interface specification for the connection between a PC and a monitor. The projected image, sound and control signal without compressed enable to be sent/received with one cable. Only the input signal of this product corresponds to the standard.

I/P (Interlace Progressive) Conversion

This enables to convert the scanning process of the screen from I (Interlace) to P (Progressive non interlace).

This is used to create a higher quality screen to reduce blur, etc. with video input signal digital processed through DVD, etc.

OutlineEnhancer

OutlineEnhancer functions to emphasize outline of the images by emphasizing the color difference between pixels composing the images. This may improve the texture of the material and its feel of the images.

On the contrary, it also functions to reproduce the images smoothly by gradating its outline.

Phase

Phase means the sampling timing to convert the analog input signal to a digital signal. Phase adjustment is made to adjust the timing. It is recommended that phase adjustment be made after the clock is adjusted correctly.

Range Adjustment

Range adjustment controls the signal output levels to display every color gradation. It is recommended that range adjustment be made before color adjustment.

Resolution

The LCD panel consists of numerous pixels of specified size, which are illuminated to form images. This monitor consists of 1920 horizontal pixels and 1200 vertical pixels. At a resolution of 1920 x 1200, all pixels are illuminated as a full screen (1:1).

sRGB (Standard RGB)

International standard for “color reproduction and color space” among peripheral devices (such as monitors, printers, digital cameras, scanners). sRGB allows Internet users to closely match colors as a simple color matching means for the Internet use.

Temperature

Color temperature is a method to measure the white color tone, generally indicated in degrees Kelvin. The screen becomes reddish at a low temperature, and bluish at a high temperature, like the flame temperature.

5000K: Slightly reddish white

6500K: Warm white like paper white

9300K: Slightly bluish white

5-4 Preset Timing

The following table shows factory preset video timing. (for analog signal only)

Mode	Dot clock		Frequency		Polarity
			Horizontal: kHz	Vertical: Hz	
NEC PC-9821 640x400@70 Hz	25.2 MHz	Horizontal	31.48	Negative	
		Vertical	70.10	Negative	
VGA 640x480@60 Hz	25.2 MHz	Horizontal	31.47	Negative	
		Vertical	59.94	Negative	
VGA 720x400@70 Hz	28.3 MHz	Horizontal	31.47	Negative	
		Vertical	70.09	Positive	
Macintosh 640x480@67 Hz	30.2 MHz	Horizontal	35.00	Negative	
		Vertical	66.67	Negative	
Macintosh 832x624@75 Hz	57.3 MHz	Horizontal	49.72	Negative	
		Vertical	74.55	Negative	
Macintosh 1152x870@75 Hz	100.0 MHz	Horizontal	68.68	Negative	
		Vertical	75.06	Negative	
Macintosh 1280x960@75 Hz	126.2 MHz	Horizontal	74.76	Positive	
		Vertical	74.76	Positive	
VESA 640x480@73 Hz	31.5 MHz	Horizontal	37.86	Negative	
		Vertical	72.81	Negative	
VESA 640x480@75 Hz	31.5 MHz	Horizontal	37.50	Negative	
		Vertical	75.00	Negative	
VESA 720x480@60 Hz	28.3 MHz	Horizontal	31.47	Negative	
		Vertical	59.94	Negative	
VESA 800x600@56 Hz	36.0 MHz	Horizontal	35.16	Positive	
		Vertical	56.25	Positive	
VESA 800x600@60 Hz	40.0 MHz	Horizontal	37.88	Positive	
		Vertical	60.32	Positive	
VESA 800x600@72 Hz	50.0 MHz	Horizontal	48.08	Positive	
		Vertical	72.19	Positive	
VESA 800x600@75 Hz	49.5 MHz	Horizontal	46.88	Positive	
		Vertical	75.00	Positive	
VESA 848x480@60 Hz	33.8 MHz	Horizontal	31.02	Positive	
		Vertical	60.00	Positive	
VESA 1024x768@60 Hz	65.0 MHz	Horizontal	48.36	Negative	
		Vertical	60.00	Negative	
VESA 1024x768@70 Hz	75.0 MHz	Horizontal	56.48	Negative	
		Vertical	70.07	Negative	
VESA 1024x768@75 Hz	78.8 MHz	Horizontal	60.02	Positive	
		Vertical	75.03	Positive	
VESA 1152x864@75 Hz	108.0 MHz	Horizontal	67.50	Positive	
		Vertical	75.00	Positive	
VESA CVT 1280x768	79.5 MHz	Horizontal	47.78	Negative	
		Vertical	59.87	Positive	
VESA CVT 1280x768	102.3 MHz	Horizontal	60.29	Negative	
		Vertical	74.89	Positive	
VESA CVT RB 1280x768	68.3 MHz	Horizontal	47.40	Positive	
		Vertical	60.00	Negative	
VESA 1280x960@60 Hz	108.0 MHz	Horizontal	60.00	Positive	
		Vertical	60.00	Positive	
VESA 1280x1024@60 Hz	108.0 MHz	Horizontal	63.98	Positive	
		Vertical	60.02	Positive	
VESA 1280x1024@75 Hz	135.0 MHz	Horizontal	79.98	Positive	
		Vertical	75.03	Positive	
VESA 1360x768@60 Hz	85.5 MHz	Horizontal	47.71	Positive	
		Vertical	60.02	Positive	
VESA 1600x1200@60 Hz	162.0 MHz	Horizontal	75.00	Positive	
		Vertical	60.00	Positive	
VESA CVT 1680x1050	146.3 MHz	Horizontal	65.29	Negative	
		Vertical	59.95	Positive	

Attention

- Display position may deviate depending on the PC connected, which may require screen adjustment using the Setting menu.
- If a signal other than those listed in the table is input, adjust the screen using the Setting menu. However, the screen display may still be incorrect even after the adjustment.
- When interlace signals are used, the screen cannot be displayed correctly even after screen adjustment using the Setting menu.

VESA CVT RB 1680x1050	119.0 MHz	Horizontal	64.67	Positive
		Vertical	59.88	Negative
VESA CVT RB 1920x1200	154.0 MHz	Horizontal	74.04	Positive
		Vertical	59.95	Negative

(The signals specified below are also applicable for the use of some AV equipments such as Microsoft Xbox 360.)

Mode	Dot clock		Frequency	Polarity
			Horizontal: kHz Vertical: Hz	
720@50 Hz 1280x720p	74.3 MHz	Horizontal	37.50	Positive
		Vertical	50.00	Positive
720@60 Hz 1280x720p	74.3 MHz	Horizontal	45.00	Positive
		Vertical	59.94	Positive
1080@50 Hz 1920x1080p	148.5 MHz	Horizontal	56.25	Positive
		Vertical	50.00	Positive
1080@60 Hz 1920x1080p	148.5 MHz	Horizontal	67.50	Positive
		Vertical	59.94	Positive

For U.S.A. , Canada, etc. (rated 100-120 Vac) Only

FCC Declaration of Conformity

We, the Responsible Party

EIZO NANAOTECHNOLOGIES INC.

5710 Warland Drive, Cypress, CA 90630

Phone: (562) 431-5011

declare that the product

Trade name: EIZO

Model: FlexScan MH240W

is in conformity with Part 15 of the FCC Rules. Operation of this product is subject to the following two conditions: (1) this device may not cause harmful interference, and (2) this device must accept any interference received, including interference that may cause undesired operation.

This equipment has been tested and found to comply with the limits for a Class B digital device, pursuant to Part 15 of the FCC Rules. These limits are designed to provide reasonable protection against harmful interference in a residential installation. This equipment generates, uses, and can radiate radio frequency energy and, if not installed and used in accordance with the instructions, may cause harmful interference to radio communications. However, there is no guarantee that interference will not occur in a particular installation. If this equipment does cause harmful interference to radio or television reception, which can be determined by turning the equipment off and on, the user is encouraged to try to correct the interference by one or more of the following measures.

- * Reorient or relocate the receiving antenna.
- * Increase the separation between the equipment and receiver.
- * Connect the equipment into an outlet on a circuit different from that to which the receiver is connected.
- * Consult the dealer or an experienced radio/TV technician for help.

Changes or modifications not expressly approved by the party responsible for compliance could void the user's authority to operate the equipment.

Note

Use the attached specified cable below or EIZO signal cable with this monitor so as to keep interference within the limits of a Class B digital device.

- AC Cord
- Shielded Signal Cable (DVI - DVI, D-Sub mini 15-pin - D-Sub mini 15-pin, the enclosed signal cable)

Canadian Notice

This Class B digital apparatus complies with Canadian ICES-003.

Cet appareil numérique de la classe B est conforme à la norme NMB-003 du Canada.

EMC Information



The FlexScan MH240W requires special precautions regarding EMC and need to be installed, put into service and used according to the following information.

Do not use any cables other than the cables that provided or specified by us.
Using other cables may cause the increase of emission or decrease of immunity.

Do not put any portable and mobile RF communications equipment close to the FlexScan MH240W. Doing so may affect the FlexScan MH240W.

The FlexScan MH240W should not be used adjacent to or stacked with other equipment. If adjacent or stacked use is necessary, the equipment or system should be observed to verify normal operation in the configuration in which it will be used.

Anyone who connects additional equipment to the signal input part or signal output parts, configuring a medical system, is responsible that the system complies with the requirements of EN60601-1-2:2001.

Guidance and manufacturer's declaration - electromagnetic emissions

The FlexScan MH240W is intended for use in the electromagnetic environment specified below.

The customer or the user of the FlexScan MH240W should assure that it is used in such an environment.

Emission test	Compliance	Electromagnetic environment - guidance
RF emissions EN55011	Group 1	The FlexScan MH240W uses RF energy only for its internal function. Therefore, its RF emission are very low and are not likely to cause any interference in nearby electronic equipment.
RF emissions EN55011	Class B	The FlexScan MH240W is suitable for use in all establishments, including domestic establishments and those directly connected to the public low-voltage power supply network that supplies buildings used for domestic purposes.
Harmonic emissions EN61000-3-2	Class D	
Voltage fluctuations / flicker emissions EN61000-3-3	Complies	

Guidance and manufacturer's declaration - electromagnetic immunity

The FlexScan MH240W is intended for use in the electromagnetic environment specified below.

The customer or the user of the FlexScan MH240W should assure that it is used in such an environment.

Immunity test	EN60601 test level	Compliance level	Electromagnetic environment - guidance
Electrostatic discharge (ESD) EN61000-4-2	±6kV contact ±8kV air	±6kV contact ±8kV air	Floors should be wood, concrete or ceramic tile. If floors are covered with synthetic material, the relative humidity should be at least 30%.
Electrical fast transient / burst EN61000-4-4	±2kV for power supply lines ±1kV for input/output lines	±2kV for power supply lines ±1kV for input/output lines	Mains power quality should be that of a typical commercial or hospital environment.
Surge EN61000-4-5	±1kV differential mode ±2kV common mode	±1kV differential mode ±2kV common mode	Mains power quality should be that of a typical commercial or hospital environment.
Voltage dips, short interruptions and voltage variations on power supply input lines EN61000-4-11	<5% U_T , for 0.5 cycle (>95% dip in U_T) 40% U_T , for 5 cycles (60% dip in U_T) 70% U_T , for 25 cycles (30% dip in U_T) <5% U_T , for 5s (>95% dip for U_T) Note: U_T is the a.c. mains voltage prior to application of the test level.	<5% U_T , for 0.5 cycle (>95% dip in U_T) 40% U_T , for 5 cycles (60% dip in U_T) 70% U_T , for 25 cycles (30% dip in U_T) <5% U_T , for 5s (>95% dip for U_T)	Mains power quality should be that of a typical commercial or hospital environment. If the user of the FlexScan MH240W requires continued operation during power mains interruptions, it is recommended that FlexScan MH240W be powered from an uninterruptible power supply or battery.
Power frequency (50/60Hz) magnetic field EN61000-4-8	3A/m	3A/m	The power frequency magnetic field should be measured in the intended installation location to assure that it is sufficiently low.

Immunity test	EN60601 test level	Compliance level	Electromagnetic environment - guidance
Conducted RF EN61000-4-6	3Vrms 150kHz to 80MHz	3Vrms 150kHz to 80MHz	Portable and mobile RF communications equipment should be used no closer to any part of the FlexScan MH240W, including cables, than the recommended separation distance calculated from the equation applicable to the frequency of the transmitter. Recommended Separation distance $d = 1.2 \sqrt{P}$
Radiated RF EN61000-4-3	3Vrms 80MHz to 2.5GHz	3Vrms 80MHz to 2.5GHz	$d = 1.2 \sqrt{P}$, 80MHz to 800MHz $d = 2.3 \sqrt{P}$, 800MHz to 2.5GHz Where "P" is the maximum output power rating of the transmitter in watts (W) according to the transmitter manufacturer and "d" is the recommended separation distance in meters (m). Field strengths from fixed RF transmitters, as determined by an electromagnetic site survey, should be less than the compliance level in each frequency range. Interference may occur in the vicinity of equipment marked with the following symbol.

Recommended separation distance between portable and mobile RF communications equipment and the FlexScan MH240W

The FlexScan MH240W is intended for use in an electromagnetic environment in which radiated RF disturbances are controlled. The customer or the user of the FlexScan MH240W can help prevent electromagnetic interference by maintaining a minimum distance between portable and mobile RF communications equipment (transmitters) and the FlexScan MH240W as recommended below, according to the maximum output power of the communications equipment.

Rated maximum output power of transmitter W	Separation distance according to frequency of transmitter m		
	150kHz to 80MHz $d = 1.2 \sqrt{P}$	80MHz to 800MHz $d = 1.2 \sqrt{P}$	800MHz to 2.5GHz $d = 2.3 \sqrt{P}$
0.01	0.12	0.12	0.23
0.1	0.38	0.38	0.73
1	1.2	1.2	2.3
10	3.8	3.8	7.3
100	12	12	23

For transmitters rated at a maximum output power not listed above, the recommended separation distance "d" in meters (m) can be estimated using the equation applicable to the frequency of the transmitter, where "P" is the maximum output power rating of the transmitter in watts (W) according to the transmitter manufacturer.

These guidelines may not apply in all situations. Electromagnetic propagation is affected by absorption and reflection from structures, objects and people.

Cable length		
Power Cord :	Accessory	2.0m
Signal Cable (FD-C39) :	Accessory	2.0m
Signal Cable (MD-C87) :	Accessory	1.8m
USB Cable (MD-C93) :	Accessory	1.8m

Hinweise zur Auswahl des richtigen Schwenkarms für Ihren Monitor

Dieser Monitor ist für Bildschirmarbeitsplätze vorgesehen. Wenn nicht der zum Standardzubehör gehörige Schwenkarm verwendet wird, muss statt dessen ein geeigneter anderer Schwenkarm installiert werden. Bei der Auswahl des Schwenkarms sind die nachstehenden Hinweise zu berücksichtigen:

Der Standfuß muß den nachfolgenden Anforderungen entsprechen:

- a) Der Standfuß muß eine ausreichende mechanische Stabilität zur Aufnahme des Gewichtes vom Bildschirmgerät und des spezifizierten Zubehörs besitzen. Das Gewicht des Bildschirmgerätes und des Zubehörs sind in der zugehörigen Bedienungsanleitung angegeben.
- b) Die Befestigung des Standfusses muß derart erfolgen, daß die oberste Zeile der Bildschirmanzeige nicht höher als die Augenhöhe eines Benutzers in sitzender Position ist.
- c) Im Fall eines stehenden Benutzers muß die Befestigung des Bildschirmgerätes derart erfolgen, daß die Höhe der Bildschirmmitte über dem Boden zwischen 135 – 150 cm beträgt.
- d) Der Standfuß muß die Möglichkeit zur Neigung des Bildschirmgerätes besitzen (max. vorwärts: 5°, min. nach hinten $\geq 5^\circ$).
- e) Der Standfuß muß die Möglichkeit zur Drehung des Bildschirmgerätes besitzen (max. $\pm 180^\circ$). Der maximale Kraftaufwand dafür muß weniger als 100 N betragen.
- f) Der Standfuß muß in der Stellung verharren, in die er manuell bewegt wurde.
- g) Der Glanzgrad des Standfusses muß weniger als 20 Glanzeinheiten betragen (seidenmatt).
- h) Der Standfuß mit Bildschirmgerät muß bei einer Neigung von bis zu 10° aus der normalen aufrechten Position kipp sicher sein.



EIZO NANA O CORPORATION

153 Shimokashiwano, Hakusan, Ishikawa 924-8566 Japan
Phone: +81 76 277 6792 Fax: +81 76 277 6793

EIZO NANA O TECHNOLOGIES INC.

5710 Warland Drive, Cypress, CA 90630, U.S.A.
Phone: +1 562 431 5011 Fax: +1 562 431 4811

EIZO EUROPE AB

Lovangsvagen 14 194 61, Upplands Väsby, Sweden
Phone: +46 8 594 105 00 Fax: +46 8 590 91 575

EIZO NANA O AG

Moosacherstrasse 6, Au CH - 8820 Wädenswil, Switzerland
Phone: +41-0-44 782 24 40 Fax: +41-0-44 782 24 50

Avnet Technology Solutions GmbH

Lötscher Weg 66, D-41334 Nettetal, Germany
Phone: +49 2153 733-400 Fax: +49 2153 733-483

<http://www.eizo.com>



1st Edition-June, 2008

03V22419A1
(U.M-MH240W)