

User's Manual Bedienungsanleitung Manuel d'utilisation

RadiForce® R31-C

Color LCD Monitor
LCD-Farbmonitor
Moniteur couleur LCD

Important

Please read this User's Manual carefully to familiarize yourself with safe and effective usage procedures. Please retain this manual for future reference.

Wichtig

Bitte lesen Sie diese Bedienungsanleitung sorgfältig durch, um sich mit dem sicheren und rationellen Betrieb dieses Produkts vertraut zu machen. Bewahren Sie das vorliegende Handbuch zu Referenzzwecken auf.

Important

Veuillez lire attentivement ce manuel d'utilisation pour utiliser pleinement votre appareil en toute sécurité. Veuillez conserver ce manuel pour référence ultérieure.



User's Manual

RadiForce[®] R31-C

Color LCD Monitor

It shall be assured that the final system is in compliance to IEC60601-1-1 requirements.

SAFETY SYMBOLS

This manual uses the safety symbols below. They denote critical information. Please read them carefully.



WARNING

Failure to abide by the information in a WARNING may result in serious injury and can be life threatening.



CAUTION

Failure to abide by the information in a CAUTION may result in moderate injury and/or property or product damage.



Indicates a prohibited action.



Indicates to ground for safety.

- Power supplied equipment can emit electromagnetic waves, that could influence, limit or result in malfunction of the monitor. Install the equipment in a controlled environment, where such effects are avoided.
- This is a monitor intended for use in a medical image system.

Copyright© 2005-2007 EIZO NANAO CORPORATION All rights reserved. No part of this manual may be reproduced, stored in a retrieval system, or transmitted, in any form or by any means, electronic, mechanical, or otherwise, without the prior written permission of EIZO NANAO CORPORATION.

EIZO NANAO CORPORATION is under no obligation to hold any submitted material or information confidential unless prior arrangements are made pursuant to EIZO NANAO CORPORATION's receipt of said information. Although every effort has been made to ensure that this manual provides up-to-date information, please note that EIZO monitor specifications are subject to change without notice.

Apple and Macintosh are registered trademarks of Apple, Inc.

VGA is a registered trademark of International Business Machines Corporation.

DPMS is a trademark and VESA is a registered trademark of Video Electronics Standards Association.

Windows is a registered trademark of Microsoft Corporation.

PowerManager, RadiCS and RadiNET Pro are trademarks of EIZO NANAO CORPORATION.

ScreenManager, RadiForce and EIZO are registered trademarks of EIZO NANAO CORPORATION in Japan and other countries.

TABLE OF CONTENTS



PRECAUTIONS	4
1. INTRODUCTION	9
1-1. Features	9
1-2. Package Contents.....	9
1-3. Controls & Connectors	10
2. CABLE CONNECTIONS	12
2-1. Before Connecting	12
2-2. Single Link Cable Connection.....	13
2-3. Dual Link Cable Connection	16
2-4. 10bit Color Signal Input.....	19
3. MENUS & FUNCTIONS	20
3-1. ScreenManager	20
3-2. CAL Switch Function.....	22
3-3. Other Useful Functions	23
4. ADJUSTMENTS & SETTINGS	25
4-1. Color Adjustment	25
4-2. Image Adjustments	27
4-3. Power-save Setup.....	28
5. MAKING USE OF USB (Universal Serial Bus)	29
6. ATTACHING AN ARM	31
7. TROUBLESHOOTING	32
8. CLEANING	35
9. SPECIFICATIONS	36
10. GLOSSARY	39

PRECAUTIONS







IMPORTANT!

- This product has been adjusted specifically for use in the region to which it was originally shipped. If operated outside the region to which it was originally shipped, the product may not perform as stated in the specifications.
- To ensure personal safety and proper maintenance, please read this section and the caution statements on the unit (refer to the figure below).

[Location of the Caution Statements]



[Symbols on the unit]

Symbol	Location	This symbol indicates
	Side	Main power switch Press to turn the monitor's main power off.
	Side	Main power switch Press to turn the monitor's main power on.
	Front Control panel	Power button Press to turn the monitor's power on or off.
	Rear Name Plate	Alternating current
	Rear	Alerting electrical hazard
	Rear	Caution Refer to SAFETY SYMBOLS section in this manual.

WARNING

If the unit begins to emit smoke, smells like something is burning, or makes strange noises, disconnect all power connections immediately and contact your dealer for advice.

Attempting to use a malfunctioning unit may result in fire, electric shock, or equipment damage.

Do not open the cabinet or modify the unit.

Opening the cabinet or modifying the unit may result in fire, electric shock, or burn.



Refer all servicing to qualified service personnel.

Do not attempt to service this product yourself as opening or removing covers may result in fire, electric shock, or equipment damage.

Keep small objects or liquids away from the unit.

Small objects accidentally falling through the ventilation slots into the cabinet or spillage into the cabinet may result in fire, electric shock, or equipment damage.

If an object or liquid falls/spills into the cabinet, unplug the unit immediately. Have the unit checked by a qualified service engineer before using it again.

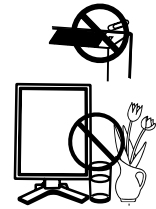

Place the unit at the strong and stable place.

A unit placed on an inadequate surface may fall and result in injury or equipment damage.

If the unit falls, disconnect the power immediately and ask your dealer for advice. Do not continue using a damaged unit. Using a damaged unit may result in fire or electric shock.

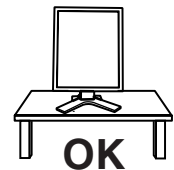

Set the unit in an appropriate location.

Not doing so may result in fire, electric shock, or equipment damage.

- * Do not place outdoors.
- * Do not place in the transportation system (ship, aircraft, trains, automobiles, etc.)
- * Do not place in a dusty or humid environment.
- * Do not place in a location where the steam comes directly on the screen.
- * Do not place near heat generating devices or a humidifier.
- * Do not place in an inflammable gas environment.

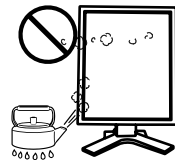

To avoid danger of suffocation, keep the plastic packing bags away from babies and children.

Use the enclosed power cord and connect to the standard power outlet of your country.

Be sure to remain within the rated voltage of the power cord.

Not doing so may result in fire or electric shock.

Power supply: 100-120/200-240 VAC±10 %, 50/60 Hz

WARNING

To disconnect the power cord, grasp the plug firmly and pull.

Tugging on the cord may damage and result in fire or electric shock.



The equipment must be connected to a grounded main outlet.

Not doing so may result in fire or electric shock.



Use the correct voltage.

* The unit is designed for use with a specific voltage only. Connection to another voltage than specified in this User's Manual may cause fire, electric shock, or equipment damage.

Power supply: 100-120/200-240 VAC±10 %, 50/60 Hz

* Do not overload your power circuit, as this may result in fire or electric shock.

Handle the power cord with care.

* Do not place the cord underneath the unit or other heavy objects.

* Do not pull on or tie the cord.

If the power cord becomes damaged, stop using it. Use of a damaged cord may result in fire or electric shock.

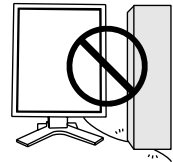

Never touch the plug and power cord if it begins to thunder.

Touching them may result in electric shock.

When attaching an arm stand, please refer to the user's manual of the arm stand and install the unit securely.

Not doing so may cause the unit to come unattached, which may result in injury or equipment damage. When the unit is dropped, please ask your dealer for advice. Do not continue using a damaged unit. Using a damaged unit may result in fire or electric shock. When reattaching the tilt stand, please use the same screws and tighten them securely.

WARNING

Do not touch a damaged LCD panel directly with bare hands.

The liquid crystal which leaks from the panel is poisonous if it enters the eyes or mouth.

If any part of the skin or body comes in direct contact with the panel, please wash thoroughly. If some physical symptoms result, please consult your doctor.



Follow local regulation or laws for safe disposal.

The backlight of the LCD panel contains mercury.

CAUTION

Handle with care when carrying the unit.

Disconnect the power cord and cables when moving the unit. Moving the unit with the cord attached is dangerous. It may result in injury.

When handling the unit, grip the bottom of the unit firmly with both hands ensuring the panel faces outward before lifting.

Dropping the unit may result in injury or equipment damage.



Do not block the ventilation slots on the cabinet.

- * Do not place any objects on the ventilation slots.
- * Do not install the unit in a closed space.
- * Do not use the unit laid down or upside down.

Blocking the ventilation slots prevents proper airflow and may result in fire, electric shock, or equipment damage.



Do not touch the plug with wet hands.

Doing so may result in electrical shock.



Use an easily accessible power outlet.

This will ensure that you can disconnect the power quickly in case of a problem.

Periodically clean the area around the plug.

Dust, water, or oil on the plug may result in fire.

Unplug the unit before cleaning it.

Cleaning the unit while it is plugged into a power outlet may result in electric shock.

If you plan to leave the unit unused for an extended period, disconnect the power cord from the wall socket after turning off the power switch for the safety and the power conservation.

LCD Panel

The screen may have defective pixels. These pixels may appear as slightly light or dark area on the screen. This is due to the characteristics of the panel itself, and not the product.

The backlight of the LCD panel has a fixed life span. When the screen becomes dark or begins to flicker, please contact your dealer.

Do not press on the panel or edge of the frame strongly, as this may result in the display malfunction, such as the interference patterns, etc. If pressure is continually applied to the LCD panel, it may deteriorate or damage your LCD panel. (If the pressure marks remain on the LCD panel, leave the monitor with a white or black screen. The symptom may disappear.)

Do not scratch or press on the panel with any sharp objects, such as a pencil or pen as this may result in damage to the panel. Do not attempt to brush with tissues as this may scratch the LCD panel.

When the screen image is changed after displaying the same image for extended periods of time, an afterimage may appear. Use the screen saver or timer to avoid displaying the same image for extended periods of time.

When the monitor is cold and brought into a room or the room temperature goes up quickly, dew condensation may occur inside and outside the monitor. In that case, do not turn the monitor on and wait until dew condensation disappears, otherwise it may cause some damages to it.

1. INTRODUCTION

Thank you for choosing an EIZO Color Monitor.

1-1. Features

- DVI Digital input compliant (see p.39; for TMDS, see p.40)
- [Horizontal scanning frequency] 31 - 127 kHz
 [Vertical scanning frequency] 59 - 61 Hz
 (VGA text: 69 - 71 Hz, QXGA: 29- 61 Hz)
- [Resolution] 3M pixels (Portrait: 1536 × 2048 dots (H × V))
- [Frame synchronous mode] 59 - 61 Hz supported
- Selectable screen compliant with DICOM Part 14 (see p.39)
- Cal Switch function for selecting an optimal calibration mode (see p.22)
- USB (Universal Serial Bus) hub support (see p. 29)
- Utility software “ScreenManager Pro for Medical”, which enables control of the monitor from a Windows PC with a mouse or keyboard (refer to the EIZO LCD Utility Disk).
- Monitor stand adjustable for different heights
- Ultra slim bezel
- Image Rotation function (see p. 23)
- Dual Link connection support (see p.40)
- 10bit color signal input support
- Signal cable for Dual Link connection supplied

NOTE

- Only designated frequencies are supported for horizontal and vertical scanning.
- Before a 10bit color signal can be input, your graphics board must be configured. For details, refer to the user's manual for the graphics board.

1-2. Package Contents

Please contact your local dealer for assistance if any of the listed items are missing or damaged.

- | | |
|-----------------------------|---------------------------------|
| • LCD Monitor ¹ | • EIZO LCD Utility Disk |
| • Power Cord | • User's Manual |
| • Signal Cable (DD200DL-BK) | • ScreenManager Quick Reference |
| • EIZO USB Cable (MD-C93) | • LIMITED WARRANTY |
| | • Cleaning kit “ScreenCleaner” |

¹ The landscape position is the default monitor orientation. For the portrait position, rotate the monitor ninety degrees counter-clockwise before installing it.

NOTE

- Please retain the packing materials for future transport of the monitor.

1-3. Controls & Connectors

Front

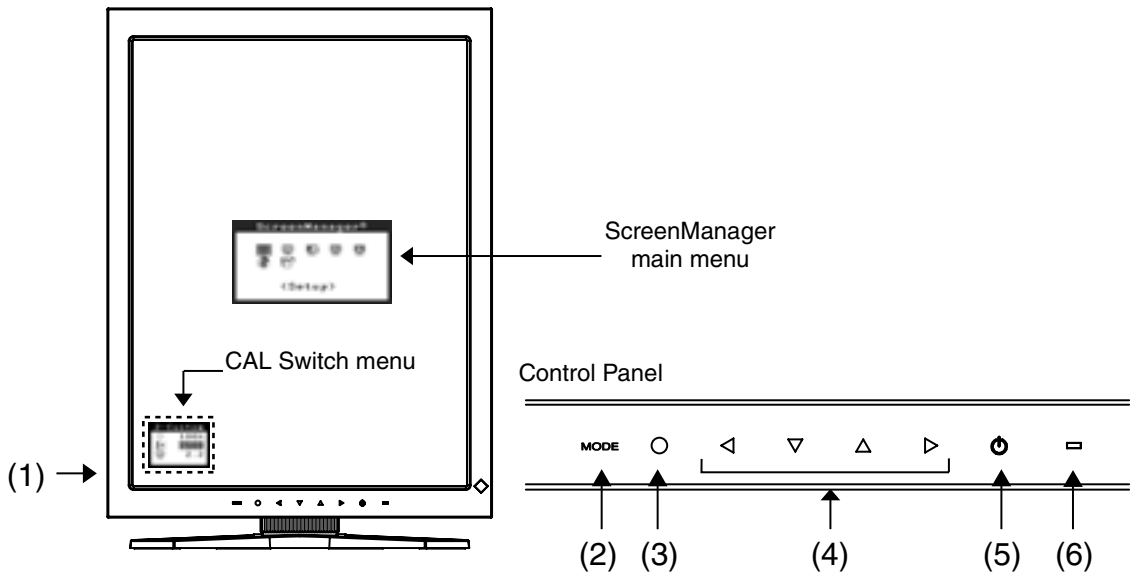

- (1) IO Main Power Switch
- (2) MODE Mode Switch
- (3) ENTER Enter Switch
- (4) <◁▷△▽> Directing Switches (Left, Down, Up, Right)¹
- (5) ⏻ Power Switch
- (6) Power Indicator²

Green	The screen is displayed
Orange	Power saving
Flashing orange slowly	Power off (Main power is on)
Off	Main Power off



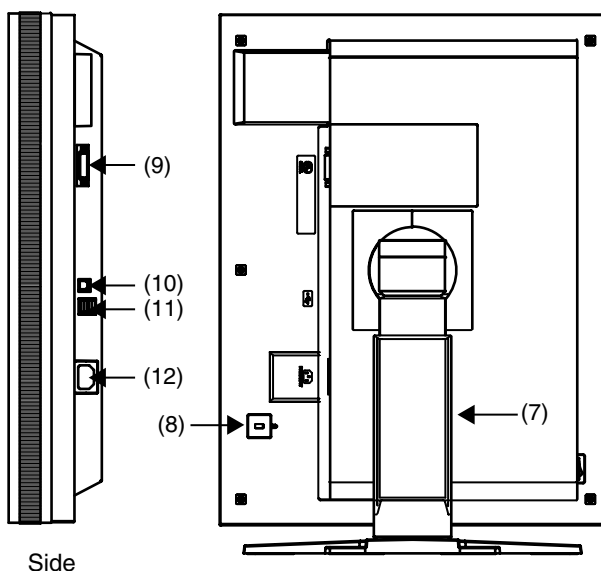

¹ (Right, Up, Down, Left) when the monitor is oriented in landscape position.

² To disable the power indicator while the monitor is operational, see page 23. For power indicator status when using the "Off Timer," see page 24.

Side / Rear



(7) Monitor stand with adjustable height (detachable)³

- (8)  Security lock slot⁴
- (9)  DVI-D input connector
- (10)  USB upstream port (x 1)
- (11)  USB downstream ports (x 2)
- (12)  Power connector

³ The LCD monitor can be oriented in the landscape position. (It can rotate clockwise ninety degrees.)
By removing the monitor stand, the LCD monitor can be used with the optional arm stand (see p. 31).

⁴ Allows for connection of a security cable. This lock supports Kensington's MicroSaver security system. For further information, please consult

Kensington Technology Group
2855 Campus Drive, San Mateo, CA 94403 USA
Tel.: 800-650-4242, x3348, Intl: 650-572-2700, x3348
Fax: 650-572-9675
<http://www.kensington.com>

2. CABLE CONNECTIONS

2-1. Before Connecting

- The procedure for connecting the monitor differs depending on the connection method chosen (Single Link or Dual Link). Verify the graphics board and connection method, and then perform the appropriate connection steps. For optional graphics boards (not supplied), refer to page 37 to verify the connection method.
- Before connecting your monitor to the PC, change the display screen settings resolution (see p.39) and frequency in accordance with the charts below.

NOTE

- When your computer and display support VESA DDC, the appropriate resolution and the refresh rate are set just by plugging your display into the computer without any manual settings.

Single Link Connection

Resolution		Frequency	Dot Clock	Display mode	
				Portrait	Landscape
720×400	VGA TEXT	70 Hz	165 MHz (Max.)	√	√
640×480	VGA	60 Hz		√	√
800×600	VESA	60 Hz		–	√
1024×768	VESA	60 Hz		–	√
1280×1024	VESA	60 Hz		–	√
1600×1200	VESA	60 Hz		–	√
1536×2048	Reduced	~ 46 Hz		√	–
2048×1536	Reduced	~ 49 Hz		–	√

“√“: Supported

Dual Link Connection

Resolution		Frequency	Dot Clock	Display mode	
				Portrait	Landscape
720×400	VGA TEXT	70 Hz	215 MHz (Max.)	√	√
640×480	VGA	60 Hz		√	√
800×600	VESA	60 Hz		–	√
1024×768	VESA	60 Hz		–	√
1280×1024	VESA	60 Hz		–	√
1600×1200	VESA	60 Hz		–	√
1536×2048	Dual Link	60 Hz		√	–
2048×1536	Dual Link	60 Hz		–	√

2-2. Single Link Cable Connection

NOTE

- Be sure that the power switches of both the PC and the monitor are OFF.
- Refer also to the PC user's manual when connecting the monitor.

1. Rotate the monitor ninety degrees counter-clockwise into the portrait position.

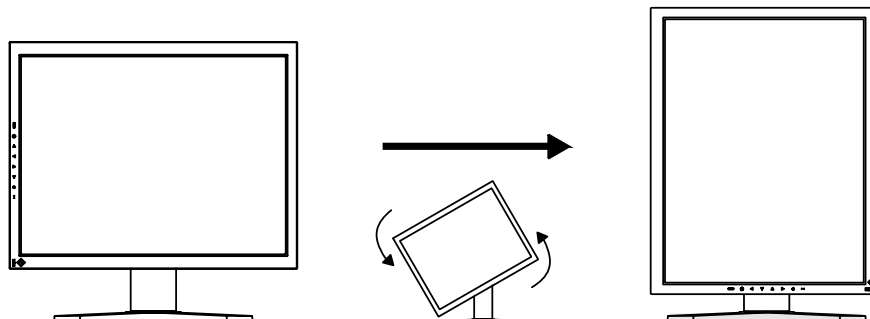

2. Connect the signal cable to the DVI-D input connector on the rear of the monitor and to the video output connector on the PC.

After connecting, secure the cable connectors with the attached screw-in fasteners.

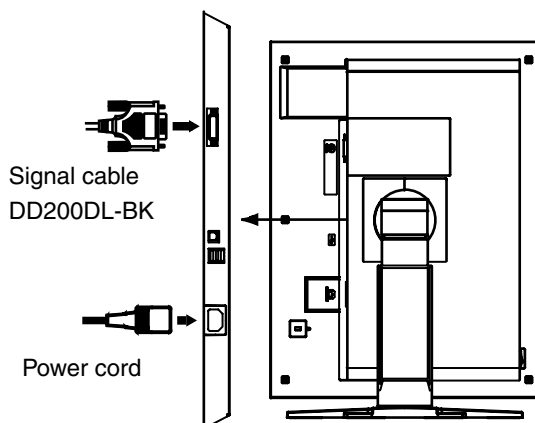

Signal Cable	Connector	PC
Signal cable (DD200DL-BK) 	Video output connector / DVI	Exclusive graphics board (See p.37)

3. Connect the power cord to the power connector on the rear of the monitor.

4. Thread the power cord and signal cable through the cable holder on the rear of the monitor stand.

NOTE

- When threading the cables through the cable holder, lead them to the cable entrance side and pinch the projection to open the cable entrance.
- It is recommended that some slack be left in the cables to allow for smooth adjustment of the monitor stand and easy rotation between the portrait and landscape positions.

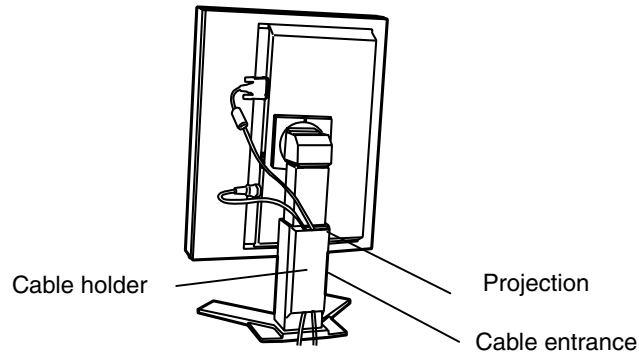

5. Connect the other end of the power cord to a power outlet.

The monitor's power indicator will flash orange slowly.

⚠ WARNING

Use the enclosed power cord and connect to the standard power outlet of your country.

Be sure to remain within the rated voltage of the power cord.

Not doing so may result in fire or electric shock.

The equipment must be connected to a grounded main outlet.

Not doing so may result in fire or electric shock.



6. Turn on the monitor's power by touching the power switch.

The monitor's power indicator will light up green.

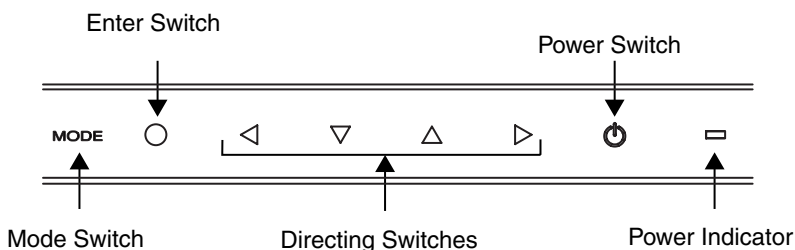

7. Turn on the PC's power.

If an image does not appear, refer to “7. TROUBLESHOOTING” (see p. 32) for additional advice.

When finished, turn off the PC and the monitor.

NOTE

- Adjust the brightness of the screen depending on the brightness of your environment.
- Be sure to take adequate rests. A 10-minute rest period each hour is suggested.

8. When using the software “ScreenManager Pro for Medical,” connect the USB upstream port on the rear of the monitor to a USB-compliant downstream port on the Windows PC or hub with the USB cable.

After connecting the USB cable, USB functionality is set up automatically. For further details about “ScreenManager Pro for Medical”, refer to “readme.txt” on the “EIZO LCD Utility Disk” CD-ROM.

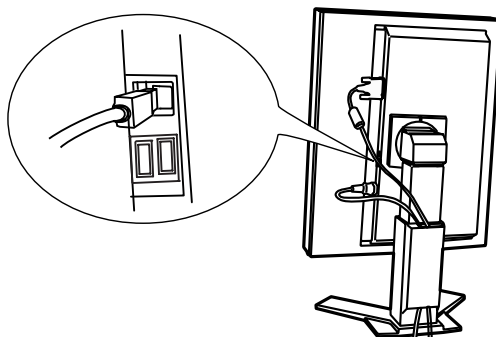

2-3. Dual Link Cable Connection

NOTE

- Be sure that the power switches of both the PC and the monitor are OFF.
- Refer also to the PC user's manual when connecting the monitor.

1. Rotate the monitor ninety degrees counter-clockwise into the portrait position.

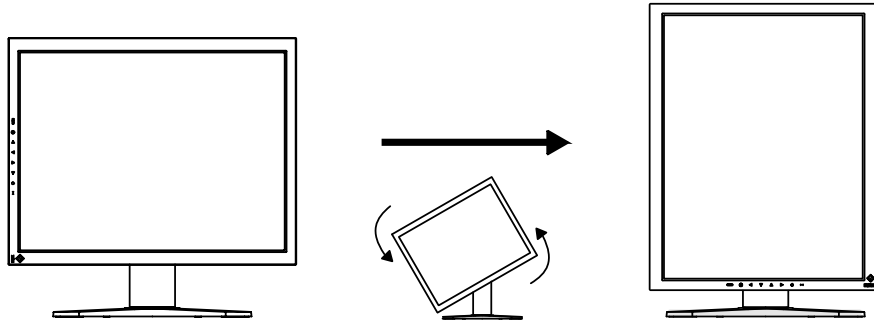

2. Connect the signal cable to the DVI-D input connector on the rear of the monitor and to the video output connector on the PC.

After connecting, secure the cable connectors with the attached screw-in fasteners.

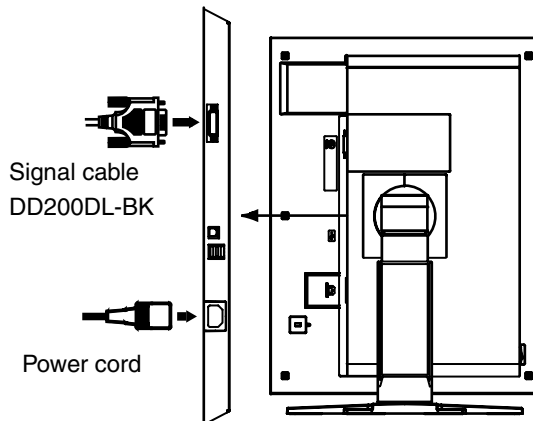

Signal Cable	Connector	PC
Signal cable (DD200DL-BK) 	Video output connector / DVI	Exclusive graphics board (See p.37)

3. Connect the power cord to the power connector on the rear of the monitor.

4. Thread the power cord and signal cable through the cable holder on the rear of the monitor stand.

NOTE

- When threading the cables through the cable holder, lead them to the cable entrance side and pinch the projection to open the cable entrance.
- It is recommended that some slack be left in the cables to allow for smooth adjustment of the monitor stand and easy rotation between the portrait and landscape positions.

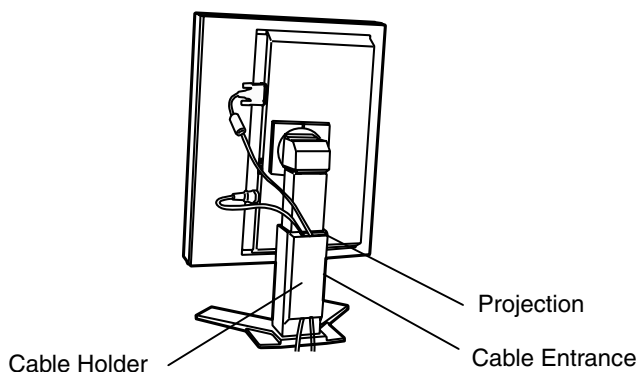

5. Connect the other end of the power cord to a power outlet.

The monitor's power indicator will flash orange slowly.

**WARNING**

Use the enclosed power cord and connect to the standard power outlet of your country.

Be sure to remain within the rated voltage of the power cord.

Not doing so may result in fire or electric shock.

The equipment must be connected to a grounded main outlet.

Not doing so may result in fire or electric shock.



6. Touch the power switch while touching the mode switch.

The “Signal Selection” menu appears on the screen.

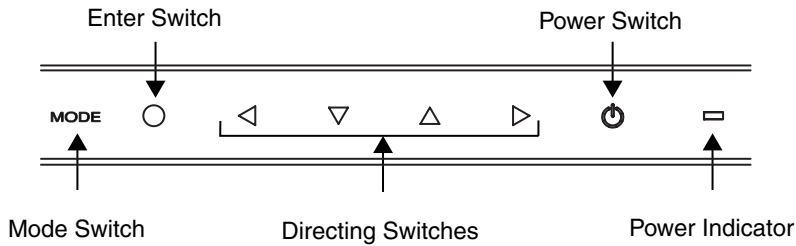

7. Change the “Signal Selection” setting to “Dual Link” with the Up and Down directing switches.

Touch the enter switch to exit the menu.

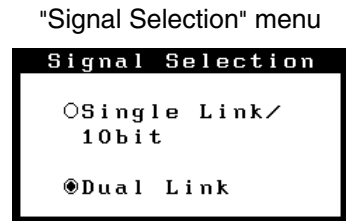

8. Switch on the PC's power.

If an image does not appear, refer to “7. TROUBLESHOOTING” (see p. 32) for additional advice.

When finished, turn off the PC and the monitor.

NOTE

- To change the connection method to Single Link, change the “Signal Selection” setting to “Single Link / 10bit” before turning on the computer.

9. When using the software “ScreenManager Pro for Medical,” connect the USB upstream port on the rear of the monitor to a USB-compliant downstream port on the Windows PC or hub with the USB cable.

After connecting the USB cable, USB functionality is set up automatically. For further details about “ScreenManager Pro for Medical,” refer to “readme.txt” on the “EIZO LCD Utility Disk” CD-ROM.

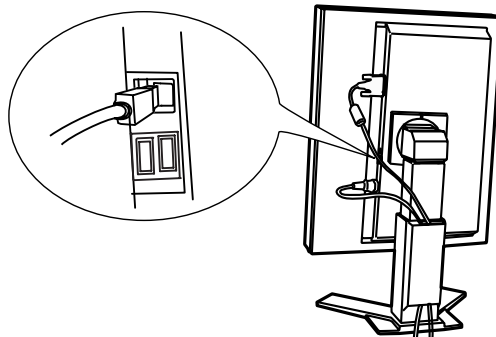

2-4. 10bit Color Signal Input

- Before a 10bit color signal can be input, your graphics board must be configured. For details, refer to the user's manual for the graphics board.
- For more on connecting the monitor and computer, refer to “2-2. Single Link Cable Connection” (see p. 13)
- If the image does not display correctly, verify the “Signal Selection” settings.

Verifying “Signal Selection” Settings

- (1) Turn off the monitor's power by touching the power switch.
- (2) Touch the power switch while touching the mode switch.
The “Signal Selection” menu appears on the screen.

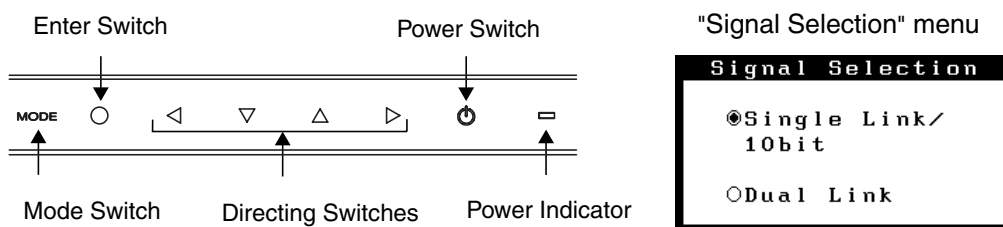

- (3) Select “Single Link/10bit” and touch the enter switch.

3. MENUS & FUNCTIONS

3-1. ScreenManager

Screen adjustments and settings can be performed with the monitor controls.

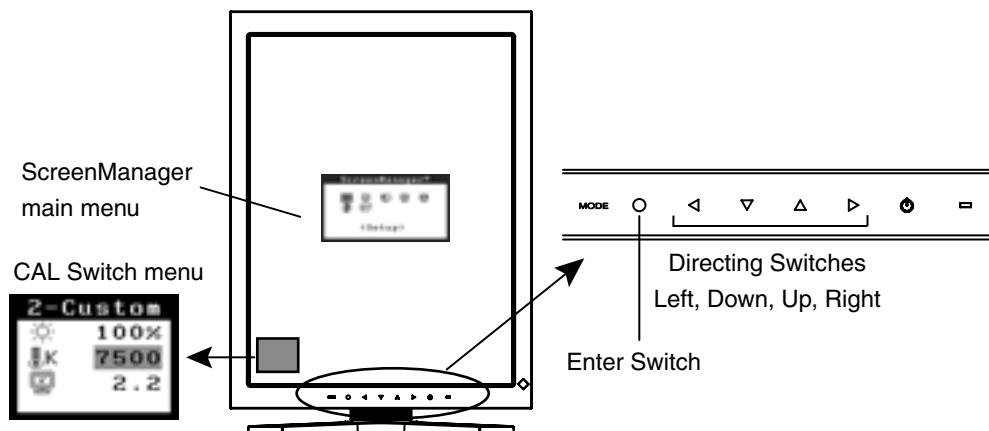

NOTE

- The ScreenManager menu and CAL Switch menu cannot be displayed at the same time.

How to use the ScreenManager

[Entering the ScreenManager]

- (1) Touch the enter switch.

[Making adjustments and settings]

- (1) Select the desired submenu icon with the directing switches and touch the enter switch.
- (2) Select the desired setting icon with the directing switches and touch the enter switch.
- (3) Make any required adjustments with the directing switches.

[Exiting the ScreenManager]

- (1) To return to the main menu, select the <Return> icon or touch the Down directing switch twice, followed by the enter switch.
- (2) To exit the ScreenManager, select the <Exit> icon or touch the Down directing switch twice, followed by the enter switch.

NOTE

- Touching the enter switch twice also exits the ScreenManager.

ScreenManager Menus and Settings.

The following table briefly explains each of the menus and settings in the ScreenManager.

Main menu	Sub menu	Explanation	
Setup	ImageRotation	See 3-3. Other Useful Functions (p. 23)	
	Mode Preset		
Color (2-Custom) ¹	Brightness	See 4-1. Color Adjustment (p. 25)	
	Temperature		
	Gamma		
	Saturation		
	Hue		
	Gain		
	6 Colors		
	Reset		
PowerManager	DVI DMPM	See 4-3. Power-save Setup (p. 28)	
Others	Screen Size	See 4-2. Image Adjustments (p. 27)	
	Smoothing		
	Border Intensity		
	Off Timer	Turn off the monitor after a specified time (see p. 24).	
	Menu Settings	Menu Size	Change the size of the menu.
		Menu Position	Adjust the menu position
		Menu Off Timer	Adjust how long to display the menu. ²
		Translucent	Adjust the transparency of the background.
Power Indicator	Disable the green power indicator (see p. 23).		
Reset	Restore the factory default settings (see p. 37).		
Information	Information	View the ScreenManager settings, model name, serial number, and usage time ³ .	
Language	English, German, French, Spanish, Italian, Swedish and Japanese	Select the language of the ScreenManager menus.	

¹ The settings available for adjustment will differ depending on which CAL Switch mode is selected (see p. 25).

² The display time of the CAL Switch menu can be adjusted.

³ Due to factory inspection, the usage time may not be "0 hours" at time of shipping.

3-2. CAL Switch Function

Use this function to select the most suitable display mode.

The <Brightness>, <Temperature>, and <Gamma> settings can be adjusted on the CAL Switch menu.

CAL Switch Modes

Mode		Description
1-DICOM	*	Used to display images in the DICOM mode (see p. 39).
2-Custom	*	Used to adjust color setting preferences
3-CAL	*	Used for monitor calibration
4-Text		Suitable for displaying text from word processing or spreadsheet software

* Each of these modes can be calibrated independently.

The mode name can also be changed using the calibration kit (see Optional, p. 37).

How to use the CAL Switch Function

[Entering the CAL Switch menu]

- Touch the mode switch.

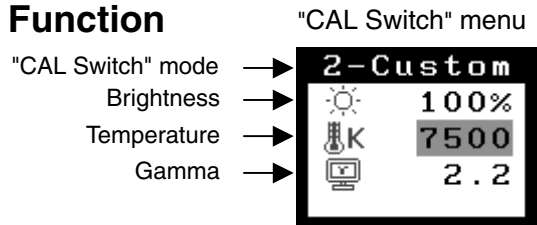

[Selecting the CAL Switch mode]

- Touch the mode switch while the CAL Switch menu is displayed.

[Making color adjustments in CAL Switch mode]

- Select the desired setting icon with the Up and Down directing switches.
- Adjust the value of the selected item with the Left and Right directing switches.

[Closing the CAL Switch menu]

- Touch the enter switch.

NOTE

- The ScreenManager menu and CAL Switch menu cannot be displayed at the same time.
- In some modes, <Temperature> and/or <Gamma> settings may be fixed at the default values (see p. 25).
- When switching between modes, the monitor can be set to display only the desired modes, skipping any unnecessary modes (see p. 23).
- Detailed color settings for each mode can be adjusted in the <Color> menu of the ScreenManager (see p.25).

3-3. Other Useful Functions

Image Rotation

This function enables the computer, at startup, to detect the orientation of the monitor and display images correctly. Disable this function when using the software's rotation function to change image display orientation.

[How to enable]

- (1) Select <Image Rotation> in the ScreenManager <Setup> menu.
- (2) Select “Enable”.
- (3) Change the orientation of the monitor and then restart the computer.

[How to disable]

- (1) Select <Image Rotation> in the ScreenManager <Setup> menu.
- (2) Select “Disable”.
- (3) Restart your computer.

NOTE

- If the orientation is changed while the computer is running, the screen will be displayed correctly once the computer is restarted.

Mode Preset

When CAL Switch mode is selected, the computer can be forced to display only specified modes. Use this function when the display modes are restricted or when the display should not be changed needlessly.

[How to set]

- (1) Select <Mode Preset> in the ScreenManager <Setup> menu.
- (2) Set each mode to “On” or “Off”.

NOTE

- You cannot disable all modes. Set one or more modes to “On”.

[How to cancel]

- (1) Select <Mode Preset> in the ScreenManager <Setup> menu.
- (2) Set the mode that you wish to display to “On”.

Power Indicator

Use the function to keep the power indicator without light while the monitor is operational. (The power indicator is set by default to light when the power is turned on.)

[Procedure]

- (1) Select <Power Indicator> in the ScreenManager <Others> menu.
- (2) Select “Disable”.

Adjustment Lock

Use this function to prevent any accidental changes to the monitor settings. The following table shows which functions the adjustment lock affects.

Locked functions	<ul style="list-style-type: none"> • Adjustments and settings in the ScreenManager • Color adjustment in CAL Switch mode
Unlocked function	<ul style="list-style-type: none"> • Adjustments to the CAL Switch mode with the directing switches.

[How to lock]

- (1) Turn off the monitor power by touching the power switch.
- (2) Touch the power switch while touching the enter switch.

[How to unlock]

- (1) Turn off the monitor power by touching the power switch.
- (2) Touch the power switch while touching the enter switch, and then turn on the monitor again. The adjustment lock is released, and the screen is displayed.

NOTE

- The adjustment lock function may activate when calibration is performed with the calibration kit (see Optional, p. 37). The monitor can be unlocked using the same unlocking procedure described above.

Off Timer

The off timer function causes the monitor to turn off automatically after a predetermined amount of time has lapsed. This function was created to reduce the afterimages particular to LCD monitors, which appear when the screen is left on for long periods without use.

[How to set]

- (1) Select <Off Timer> in the ScreenManager <Others> menu.
- (2) Select “Enable” and touch the Right and Left directing switches to adjust the “On Period” (1 to 23 hours).

[Off timer system]

PC	Monitor	Power Indicator
On Period (1H - 23H)	Operational	Green
Last 15 min. in “On period”	Advance Notice ¹	Flashing green
“On period” expired	Power off	Flashing orange slowly

¹ By touching the power switch on the control panel during the Advance Notice period, the On Period can be reset to 90 minutes. Resetting can be performed an unlimited number of times.

[How to restore power]

- (1) Touch the power switch to return to a normal screen.

NOTE

- The off timer function works while the PowerManager is active, but there is no advance notice before the monitor's power is turned off.

4. ADJUSTMENTS & SETTINGS









4-1. Color Adjustment

The color settings for each CAL Switch mode can be adjusted and saved in the <Color> menu of the ScreenManager.

Available settings

The settings available for adjustment and the icons displayed in the ScreenManager will differ depending on which CAL Switch mode is selected. Refer to the following table as needed.

“√”: Adjustable “–”: Fixed at the factory

Icons	Settings		CAL Switch Mode			
			1- DICOM	2-Custom ²	3-CAL	4-Text
	Brightness	¹	√	√	√	√
	Temperature	¹	–	√	–	√
	Gamma	¹	–	√	–	√
	Saturation		–	√	–	√
	Hue		–	√	–	√
	Gain		–	√	–	–
	6 colors		–	√	–	–
	Reset		√	√	√	√









¹ These settings can also be adjusted on the CAL Switch menu (see p. 22).

² When calibration is performed in this mode using the calibration kit (see Optional, p. 37), only the brightness and reset settings can be adjusted.

NOTE

- Allow the monitor to warm up for at least 20 minutes before making color adjustments.
- The <Reset> setting restores the default color settings in the <Color> menu for the selected CAL Switch mode.
- Because each monitor is subject to individual differences, colors may appear slightly different, even for the same image, when several monitors are lined up side-by-side. When aligning the color on several monitors, use visual judgment to fine-tuning the settings.

Adjustment Contents

Menu	Description	Adjustable Range
Brightness 	Sets the brightness of the screen	0 ~ 130%
Temperature (see p. 40) 	Sets the color temperature	4000 ~ 15000 K in 500 K increments (including 9300 K). 'Off' is original color of LCD panel (normal white).
	<p>NOTE</p> <ul style="list-style-type: none"> • Values shown in Kelvin are meant only as a reference. • Setting the temperature under 4000 K or over 15000 K invalidates the color temperature setting. (The color temperature setting turns "OFF".) 	
Gamma (see p. 39) 	Sets the gamma value	1.8 ~ 2.6
Saturation 	To change the saturation	-100 ~ 100 Selecting the minimum level (-100) makes the image monochrome.
	<p>NOTE</p> <ul style="list-style-type: none"> • The <Saturation> adjustment may cause undisplayable color tone. 	
Hue 	Sets the hue value(for flesh tones, etc).	-100 ~ 100
	<p>NOTE</p> <ul style="list-style-type: none"> • The <Hue> adjustment may cause undisplayable color tone. 	
Gain (p.39) 	Sets the gain for each color (red, green, and blue)	0 ~ 100% By adjusting the red, green and blue color tones for each mode, custom colors can be defined. Display a white or gray background image and adjust the <Gain>.
	<p>NOTE</p> <ul style="list-style-type: none"> • Values shown in percentages are meant only as a reference. • Setting the <Temperature> invalidates any adjustments to the <Gain> setting and returns it to the default value. 	
6 colors 	Sets <Saturation> and <Hue> for each color (red, yellow, green, cyan, blue, and magenta)	Hue: -100 ~ 100 Saturation: -100 ~ 100
Reset 	Restores the default color settings for the selected mode	Select the <Reset>.

4-2. Image Adjustments

With this function, low-resolution images, such as VGA 640x480, can be displayed at a desired size. In addition, it is possible to adjust or set smoothing for such images and the brightness for blank border areas.

Changing the Screen Size (Landscape Position Only)

[Procedure]

- (1) Select <Screen Size> in the ScreenManager <Others> menu.
- (2) Select the screen size with the Up and Down directing switches.

Menu	Explanation
Full Screen	Stretches the image to cover the full screen, regardless of the image's resolution. Since the vertical resolution and the horizontal resolution are enlarged at different rates, some images may appear distorted.
Enlarged	Enlarges the image on the screen, regardless of the image's resolution. Since the vertical resolution and horizontal resolution are enlarged at same rates, some horizontal or vertical image may disappear.
Normal	Displays the image at the actual Screen resolution.

Example: Displaying 1280 x 1024 resolution at the three screen sizes.

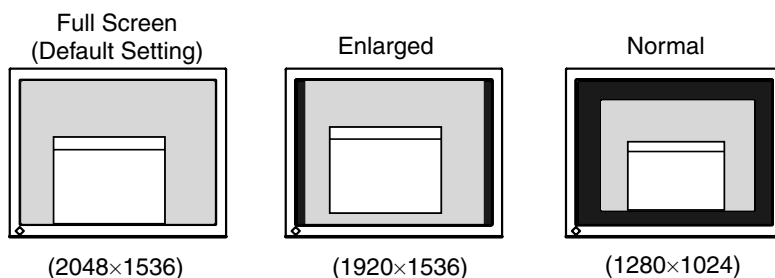

Adjustments in “Full Screen” or “Enlarged” Mode

Image smoothing can be adjusted if text or lines appear blurred when the display is set to “Full Screen” or “Enlarged” mode.

[Procedure]

- (1) Select <Smoothing> in the ScreenManager <Others> menu.
- (2) Select a suitable level of smoothing from 1 to 5 (soft to sharp) with the Left and Right directing switches.

NOTE

- <Smoothing> is disabled when the screen is displayed in the following configurations.
 - The monitor is in portrait position with <Image Rotation> enabled.
 - The screen resolution is 2048 x1536.
 - The image size is doubled both horizontally and vertically (i.e., 1024×768 enlarged to 2048×1536) to provide a clear focus.

Adjustments in “Enlarged” or “Normal” Mode

When the display is set to “Normal” or “Enlarged” mode, the brightness of the border area surrounding the image (i.e., the dark area where no image appears) can be adjusted.

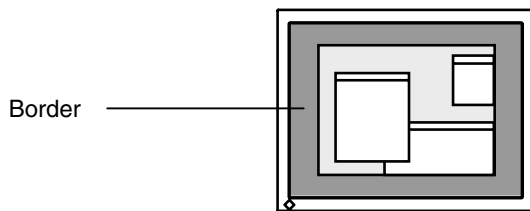

[Procedure]

- (1) Select <Border Intensity> in the ScreenManager <Others> menu.
- (2) Make adjustments with the Left and Right directing switches. The Left directing switch makes the border darker, and the Right directing switch makes it brighter.

4-3. Power-save Setup

Use the <PowerManager> menu in the ScreenManager to configure the power-save setup.

NOTE

- Do your part to conserve energy, turn off the monitor when you are finished using it. Disconnecting the monitor from the power supply is recommended to save energy completely.
- Even if the monitor is in power-saving mode, USB compliant devices draw power when they are connected to the monitor's USB ports (both upstream and downstream). Therefore, the monitor's power consumption will change according to which devices are connected, even if the monitor is in power-saving mode.

This monitor complies with the “DVI DMPM” (see p. 39).

[Procedure]

- (1) Set the PC's power saving settings.
- (2) Select “DVI DMPM” in the <PowerManager> menu.

[Power saving system]

PC	Monitor	Power Indicator
On	Operation	Green
Power saving / Off mode	Power saving	Orange

[Power Resumption Procedure]

- Click the mouse or press a key on the keyboard to return to a normal screen.

5. MAKING USE OF USB (Universal Serial Bus)

This monitor provides a hub which supports the USB standard. When connecting to a USB compliant PC or another hub, the monitor functions as a hub to which the USB compliant peripherals can be easily connected.

Required system environment

- PC equipped with USB ports or another USB hub connected to the USB compliant PC
- Windows 98/2000/Me/XP // Mac OS 8.5.1 or later
- USB Cable (MD-C93)

NOTE

- The USB hub function may not work properly depending on the PC, OS or peripherals. Please consult the manufacturer of each device about the USB support.
- When the monitor is not on, the peripherals connected to the downstream ports will not operate.
- Even if the monitor is in a power saving mode, the devices connected to the monitor's USB ports (both the upstream and the downstream) will function.
- The followings are procedures for the Windows 98/Me/2000/XP and Mac OS.

Connecting to the USB HUB

1. Connect the monitor to the PC with the signal cable (see p.12) first, then turn on the PC.
2. Connect the upstream port of the monitor to the downstream port of the USB compliant PC or another hub by using the USB cable.

After connecting the USB cable, the USB function can be set up automatically.

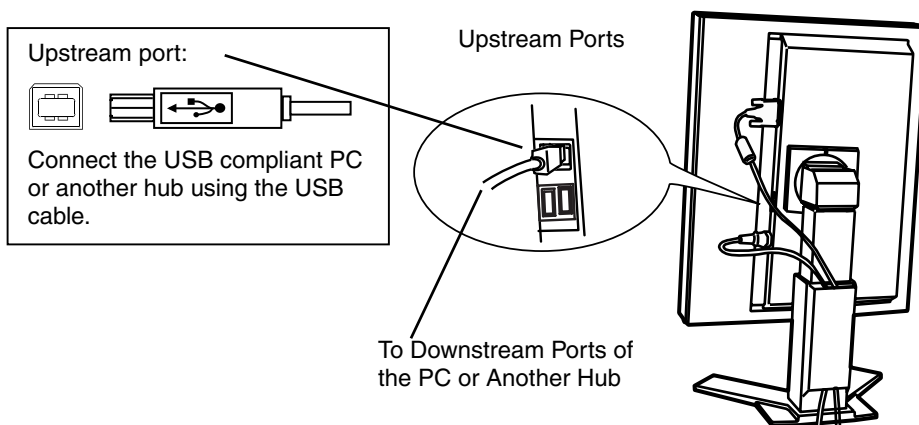

3. After setting up, the monitor's USB hub is available for connecting USB compliant peripherals to the downstream ports of the monitor.

Connecting Examples

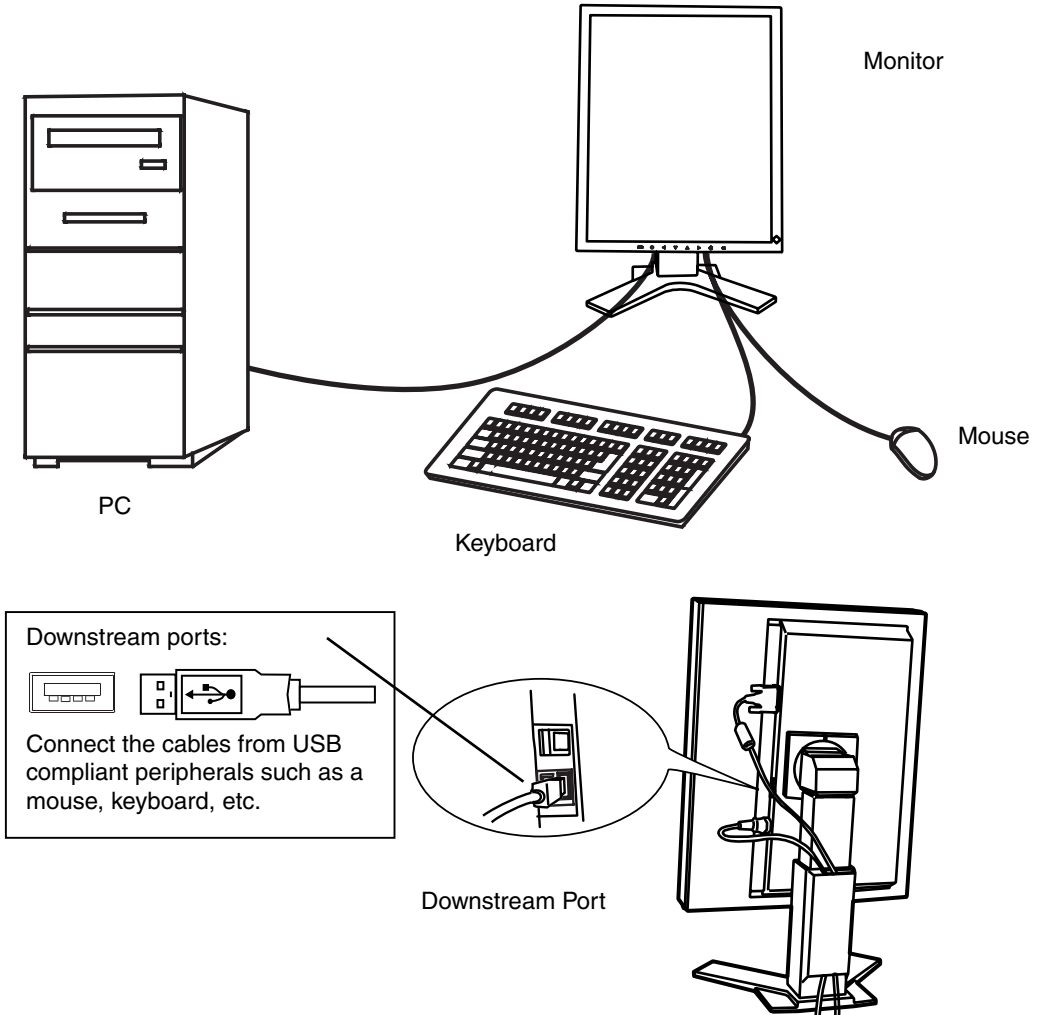

ScreenManager Pro for Medical (for Windows)

For further details about the “ScreenManager Pro for Medical (for Windows)”, refer to the EIZO LCD Utility Disk.

6. ATTACHING AN ARM

The LCD monitor can be used with an arm by removing the tilt stand and attaching the arm or stand to the LCD monitor.

NOTE

- If you will use the arm or stand of other manufacturers, confirm the followings to the manufacturers before selecting.
 - Hole spacing on the arm mounting: 100 mm x 100 mm (VESA compliant)
 - Supportable Weight: Total weight of the monitor (without stand) and attaching equipment such as a cable
 - TÜV/GS approved arm or stand
- Please connect cables after attaching an arm stand.

Setup Procedure

- 1.** Hold the center of the stand mounting cover and slide them rightward or leftward to remove the mounting cover.
- 2.** Lay the LCD monitor down. Do not scratch the panel.
- 3.** Remove the tilt stand by loosening the screws.
(4 pcs of M4 x 10)
- 4.** Attach an arm stand to the LCD monitor securely.

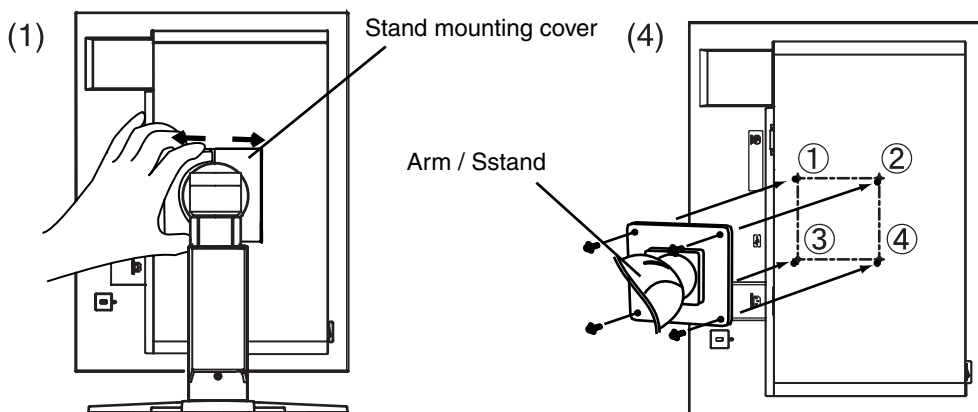

M4 Mounting Screws: M4 x 10 (mm)

7. TROUBLESHOOTING

If a problem persists even after applying the remedies suggested below, contact an EIZO dealer.

- No picture problems → See No.1 ~ No.2
- Imaging problems → See No.3 ~ No.8
- Other problems → See No.9 ~ No.13
- USB problems → See No.14 ~ No.15

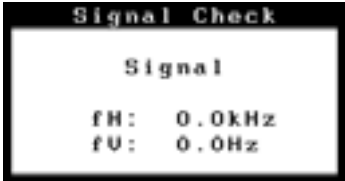
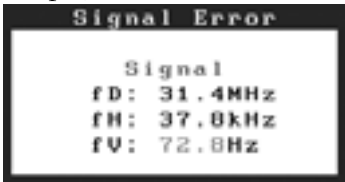
Problem	Points to check and possible solutions
1. No picture <ul style="list-style-type: none"> • Indicator status: Off 	<input type="checkbox"/> Check that the power cord is connected correctly. If the problem persists, turn off the monitor power for a few minutes, then turn it back on and try again.
<ul style="list-style-type: none"> • Indicator status: Green 	<input type="checkbox"/> Check the <Brightness> setting.
<ul style="list-style-type: none"> • Indicator status: Orange 	<input type="checkbox"/> Try pressing a key on the keyboard or clicking the mouse (see p. 28). <input type="checkbox"/> Try turning the PC on.
<ul style="list-style-type: none"> • Indicator status: Flashing orange slowly 	<input type="checkbox"/> Try touching the power switch (see p. 24).
2. One of the error messages shown below remains on the screen for 40 second. 	<p>These messages appear when the video signal is not input correctly, even if the monitor functions properly.</p> <input type="checkbox"/> The message might appear because some PCs do not output the video signal immediately after powering on. If the image is displayed correctly after a short time, there is no problem with the monitor. <input type="checkbox"/> Check that the PC is turned on. <input type="checkbox"/> Check that the signal cable is properly connected to the PC or graphics board.
<ul style="list-style-type: none"> • Whenever a signal error message appears, the signal frequency is out of range. Error signal frequency will be displayed in red. (Example) 	<input type="checkbox"/> Check that the “Signal Selection” setting is set to “Single Link/10bit” (see p. 19). <input type="checkbox"/> Use the graphics board’s utility software to change the frequency setting. (Refer to the manual of the graphics board.)
3. Only part of the screen appears.	<input type="checkbox"/> Make sure to use the supplied signal cable. <input type="checkbox"/> Check that the “Signal Selection” setting is set to “Dual Link”.

Problem	Points to check and possible solutions
4. Letters and lines appear blurred.	<input type="checkbox"/> Adjust the blurred lines using <Smoothing> (see p. 27).
5. The screen is too bright or too dark.	<input type="checkbox"/> Adjust the <Brightness> (The backlight of the LCD monitor has a fixed life span. When the screen becomes dark or begins to flicker, please contact your dealer.)
6. Afterimages appear.	<input type="checkbox"/> Do you use the screen saver or timer (p.24) when displaying the same image for extended periods of time? <input type="checkbox"/> Afterimages are particular to LCD monitors. Avoid displaying the same image for extended periods of time.
7. The screen has defective pixels (e.g. appears slightly light or dark).	<input type="checkbox"/> This is due to the characteristics of the panel itself and not the LCD product.
8. Fingerprints remain on the screen.	<input type="checkbox"/> Leaving the screen white may solve the problem.
9. <Smoothing> cannot be selected.	<input type="checkbox"/> <Smoothing> cannot be selected when the monitor is in portrait position with <Image Rotation> enabled. <input type="checkbox"/> <Smoothing> is disabled when the screen is displayed at the 2048×1536 resolution. <input type="checkbox"/> The image size is doubled both horizontally and vertically (i.e., 1024×768 enlarged to 2048×1536) to provide a clear focus.
10. The ScreenManager main menu does not operate.	<input type="checkbox"/> The adjustment lock is probably on. To unlock it, first turn off the monitor. Touch the power switch while touching the enter switch, and then turn on the monitor again (see p. 24). <input type="checkbox"/> Make sure the control panel switches are not wet or soiled. Lightly wipe the surface of the control panel, and try touching the switches again with dry hands. <input type="checkbox"/> Make sure not to wear gloves. Remove any gloves, and try touching the switches again with dry hands.
11. The control panel does not operate. CAL Switch mode does not operate.	<input type="checkbox"/> Make sure the control panel switches are not wet or soiled. Lightly wipe the surface of the control panel, and try touching the switches again with dry hands. <input type="checkbox"/> Make sure not to wear gloves. Remove any gloves, and try touching the switches again with dry hands.
12. The monitor turns off while in use.	<input type="checkbox"/> Make sure the air vents are not blocked. <input type="checkbox"/> Make sure high-temperature equipment is not located nearby.

Problem	Points to check and possible solutions
13. The signal frequency does not change after installing the “Monitor information file” from the supplied utility disk on a Windows 98/2000/Me/XP PC.	<input type="checkbox"/> Use the graphics board’s utility software to change the input signal frequency.
14. The USB function does not operate.	<input type="checkbox"/> Check that the USB cable is correctly connected. <input type="checkbox"/> Check that the PC and OS are USB compliant. (For verification of USB support, consult the manufacturer of each system.) <input type="checkbox"/> Check the USB setting in the PC's BIOS. (For details, refer to the PC user's manual.)
15. The PC freezes. The peripherals connected to the USB downstream ports do not operate.	<input type="checkbox"/> Check that the USB cable is connected correctly. <input type="checkbox"/> Try connecting the peripheral to another USB downstream port. If the problem is solved by doing this, contact an EIZO dealer. (For details, refer to the manual of the PC.) <input type="checkbox"/> Try executing the following method. <ul style="list-style-type: none">- Restarting the PC- Connecting the PC and peripherals directly If the problem is solved by doing this, contact an EIZO dealer. <input type="checkbox"/> The power switch on an Apple keyboard will not operate when connected to a USB downstream port on the monitor. Connect the keyboard directly to the Apple PC. (For details, refer to the Apple PC user's manual.)

8. CLEANING

Periodic cleaning is recommended to keep the monitor looking new and to prolong its operation lifetime.

NOTE

- Never use thinner, benzene, alcohol, abrasive cleaners, or other strong solvents, as these may cause damage to the cabinet or LCD panel.
- Make sure to turn off the monitor before cleaning it.

Cabinet

To remove stains, wipe the cabinet with a soft, lightly moistened cloth using a mild detergent. Do not spray wax or cleaner directly into the cabinet. (For details, refer to the PC user's manual.)

Panel Protector

- The surface can be cleaned with a soft cloth, such as cotton or lens paper.
- If necessary, stubborn stains can be removed by using the provided ScreenCleaner, or moistening part of a cloth with water to enhance its cleaning power.

9. SPECIFICATIONS

LCD Panel		52.9 cm (20.8 inch), TFT Monochrome LCD panel Anti-Glare Hard Coating 3H, Response Time : 50ms
Viewing Angle		Horizontal: 170°, Vertical: 170° (CR≥10)
Panel Protector		Surface treatment: Anti-reflective coating (both sides) Surface hardness: 6H pencil hardness or higher Visible reflectance: 1.0% or less Visible light transmittance: 96% or more
Dot Pitch		0.207 mm
Horizontal Scan Frequency		31 ~ 127 kHz
Vertical Scan Frequency		59 ~ 61 Hz (VGA TEXT: 69 ~ 71 Hz, QXGA : 29~ 61 Hz)
Resolution		3M pixels (Portrait: 1536 × 2048 dots (H × V))
Dot Clock (Max.)		215 MHz (Dual Link connection for 165 MHz or higher)
Display Colors		16 million colors (8bit)
Brightness (Recommended)		220cd/m ² (approx. 75%)
Display Area		423.9 mm (H) × 318.0 mm (V) (17. 0" (H) × 12.8" (V))
Power Supply		100-120/200-240 VAC±10%, 50/60 Hz, 1.1-0.9A /0.55-0.45 A
Power Consumption		Min. : 100 W Max.: 110 W (With USB) Power Saving Mode: Less than 3 W (for single signal input without USB) Main power off : 0 W
Input Connector		DVI-D x 1
Input Signal		TMDS (Single Link / Dual Link)
Signal registration		10
Plug & Play		VESA DDC 2B / EDID structure 1.3
Dimensions	With stand	368 mm (W) x 515.5~ 597.5 mm (H) x 209 mm (D) (14.5"(W) x 20.3" ~ 23.5" (H) x 8.2"(D))
	without stand	368 mm (W) x 486 mm (H) x 90mm (D) (14.5"(W) x 19.1"(H) x 3.5"(D))
Weight	With stand	10.0 kg (22 lbs.)
	without stand	7.0 kg (15.4 lbs.)
Environment Conditions	Temperature	Operating: 0 °C ~ 35 °C (32 °F ~ 95 °F) Storage: -20 °C ~ 60 °C (-4 °F ~ 140 °F)
	Humidity	30 % to 80 % R.H. Non-condensing
	Pressure	Operating: 700 to 1,060 hPa Storage: 200 to 1,060 hPa
USB	Standard	USB Specification Revision 2.0
	USB ports	Upstream port × 1, Downstream port × 2
	Communication Speed	480 Mbps (high), 12 Mbps (full), 1.5 Mbps (low)
	Power Supply	Downstream: 500 mA for each (Max.)
Certifications and Standards		TÜV Rheinland /GM, CB, NRTL/C-TÜV, CE (93/42/EEC), FCC-B
Classification of Equipment		Type of protection against electric shock: Class I EMC class: EN60601-1-2: 2001 Group 1 Class B Classification of medical device (MDD 93/42/EEC): Class I

Dimensions

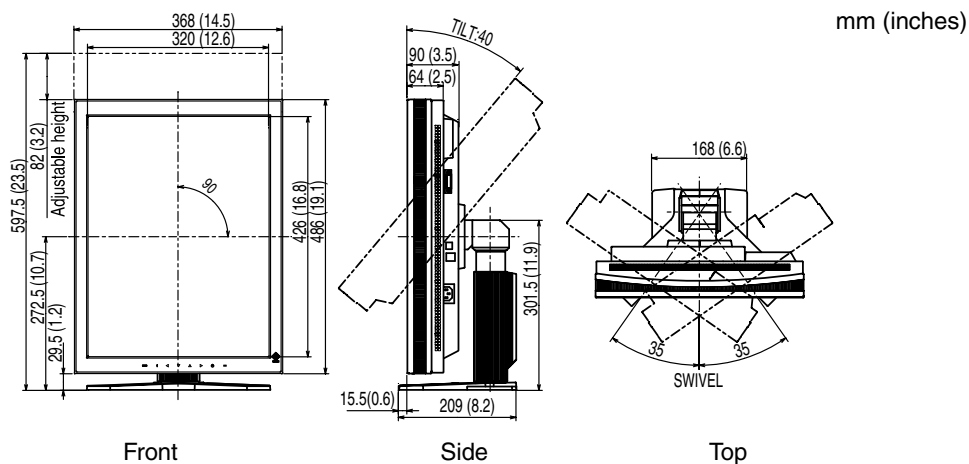

Default Settings

Signal Selection		Single Link/10bit
Image Rotation		Enable
CAL Switch Mode		1-DICOM
Brightness		Fixed at the factory
Temperature		Fixed at the factory
Smoothing		3
PowerManager		DVI DMPM
Screen Size		Normal
Off Timer		Disable
Menu Settings	Menu Size	Normal
	Menu Off Timer	45 seconds
Language		English

Optional

Arm, Stand	EIZO "LA-131-D" : LCD Monitor Flexible Arm EIZO "LA-030-W" : Wall Mount Arm for LCD Monitor EIZO "LA-011-W"
Graphics board	Dual Link connection, 10bit Color Signal output supported <ul style="list-style-type: none"> RealVision "VREngine/SMD3-DUL" <hr/> Single Link connection, 8bit Color Signal output supported <ul style="list-style-type: none"> RealVision "VREngine/SMD3-PCI" Matrox "MED3mp-PPP" Matrox "RAD-PCI"
Calibration Kit	EIZO "RadiCS RX1" Ver.2.00 or later
Network QC Management Software	EIZO "RadiNET Pro" Ver.2.00 or later

Pin Assignment

DVI-D Connector

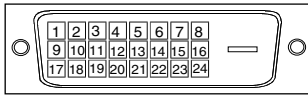

Pin No.	Signal	Pin No.	Signal	Pin No.	Signal
1	TMDS Data2-	9	TMDS Data1-	17	TMDS Data0-
2	TMDS Data2+	10	TMDS Data1+	18	TMDS Data0+
3	TMDS Data2/4 Shield	11	TMDS Data1/3 Shield	19	TMDS Data0/5 Shield
4	TMDS Data4-	12	TMDS Data3-	20	TMDS Data5-
5	TMDS Data4+	13	TMDS Data3+	21	TMDS Data5+
6	DDC Clock (SCL)	14	+5V Power	22	TMDS Clock shield
7	DDC Data (SDA)	15	Ground (For +5V)	23	TMDS Clock+
8	Analog Vertical Sync	16	Hot Plug Detect	24	TMDS Clock-

USB Port

Upstream Downstream

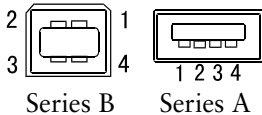

No.	Signal	Remarks
1	VCC	Cable power
2	- Data	Serial data
3	+ Data	Serial data
4	Ground	Cable Ground

10. GLOSSARY

DICOM

(Digital Imaging and Communication in Medicine)

The DICOM standard was developed by the American College of Radiology and the National Electrical Manufacturer's Association of the USA.

A DICOM-compatible device connection enables the transfer of medical images and information. Part 14 of DICOM defines the standards for digital, grayscale medical image display.

DVI

(Digital Visual Interface)

A digital flat panel interface. DVI can transmit digital data without loss and directly from the PC using the signal transition method "TMDS" (see p. 40).

There are two kinds of DVI connectors: the DVI-D connector for digital signal input only, and the DVI-I connector for both digital and analog signal inputs.

DVI DMPM

(DVI Digital Monitor Power Management)

The Power management system for the digital interface. The "Monitor ON" status (operation mode) and the "Active Off" status (power-saving mode) are indispensable for the DVI-DMPM as the monitor's power mode.

Gain Adjustment

Adjusts each color parameter for red, green and blue. The color of the LCD monitor is displayed through the color filter of the LCD panel. Red, green and blue are the three primary colors. The colors on the monitor are displayed by combining these three colors. The color tone can change by adjusting the illumination amount passed through each color's filter.

Gamma

Gamma generally refers to the nonlinear relationship between the light intensity values and the input signal level for a monitor. On the screen, low gamma values produce whitish images and high gamma values produce high-contrast images.

Resolution

The LCD panel consists of a fixed number of pixel elements which are illuminated to form the screen image. The EIZO R31-C display panel consists of 1536 horizontal pixels and 2048 vertical pixels. At a resolution of 1536 x 2048, all pixels are displayed as a full screen.

As a standard default space, sRGB allows Internet users to closely match colors.

Temperature

Color temperature is a method to measure the white color tone, generally indicated in degrees Kelvin. At high temperatures the white tone appears somewhat blue, while at lower temperatures it appears somewhat red. Computer monitors generally give best performance at high temperature settings.

5,000 K: Slightly reddish white.

6,500 K: Warm-white tone, similar to white paper or daylight.

9,300 K: Slightly bluish white.

TMDS

(Transition Minimized Differential Signaling)

A signal transition method for the digital interface. There are two types, Single Link and Dual Link, for different transition speeds.

- Single Link: 165 MPixel/s
- Dual Link: 330 MPixel/s

For U.S.A, Canada, etc. (rated 100-120 Vac) Only

FCC Declaration of Conformity

We, the Responsible Party EIZO NANA O TECHNOLOGIES INC.
5710 Warland Drive, Cypress, CA 90630
Phone: (562) 431-5011

declare that the product Trade name: EIZO
Model: RadiForce R31

is in conformity with Part 15 of the FCC Rules. Operation of this product is subject to the following two conditions: (1) this device may not cause harmful interference, and (2) this device must accept any interference received, including interference that may cause undesired operation.

This equipment has been tested and found to comply with the limits for a Class B digital device, pursuant to Part 15 of the FCC Rules. These limits are designed to provide reasonable protection against harmful interference in a residential installation. This equipment generates, uses, and can radiate radio frequency energy and, if not installed and used in accordance with the instructions, may cause harmful interference to radio communications. However, there is no guarantee that interference will not occur in a particular installation. If this equipment does cause harmful interference to radio or television reception, which can be determined by turning the equipment off and on, the user is encouraged to try to correct the interference by one or more of the following measures.

- * Reorient or relocate the receiving antenna.
- * Increase the separation between the equipment and receiver.
- * Connect the equipment into an outlet on a circuit different from that to which the receiver is connected.
- * Consult the dealer or an experienced radio/TV technician for help.

Changes or modifications not expressly approved by the party responsible for compliance could void the user's authority to operate the equipment.

Note

Use the attached specified cable below or EIZO signal cable with this monitor so as to keep interference within the limits of a Class B digital device.

- AC Cord
- Shielded Signal Cable (enclosed)

Canadian Notice

This Class B digital apparatus complies with Canadian ICES-003.
Cet appareil numérique de la classe B est conforme à la norme NMB-003 du Canada.

Recycling Information for customers in EU:

All recycling information is placed in the following websites.

Recycling-Information für Kunden in Europa:

Alle Informationen zum Thema Recycling finden Sie auf den folgenden Websites:

Informations sur le recyclage pour les clients dans l'UE:

Vous trouverez toutes les informations sur le recyclage dans les sites Web suivants:

Återvinningsinformation för kunder i EU:

All information om återvinning finns på följande webbsidor:

<http://www.swico.ch>

<http://www.eizo.de>

<http://www.eizo.se>

Recycling Information for customers in USA:

All recycling information is placed in the Eizo Nanao Technologies, Inc.'s website.

<http://www.eizo.com>



EIZO NANA O CORPORATION

153 Shimokashiwano, Hakusan, Ishikawa 924-8566 Japan
Phone: +81 76 277 6792 Fax: +81 76 277 6793

EIZO NANA O TECHNOLOGIES INC.

5710 Warland Drive, Cypress, CA 90630, U.S.A.
Phone: +1 562 431 5011 Fax: +1 562 431 4811

EIZO EUROPE AB

Lovangsvagen 14 194 61, Upplands Väsby, Sweden
Phone: +46 8 594 105 00 Fax: +46 8 590 91 575

EIZO NANA O AG

Moosacherstrasse 6, Au CH - 8820 Wädenswil, Switzerland
Phone: +41-0-44 782 24 40 Fax: +41-0-44 782 24 50

Avnet Technology Solutions GmbH

Lötscher Weg 66, D-41334 Nettetal, Germany
Phone: +49 2153 733-400 Fax: +49 2153 733-483

<http://www.radiforce.com>

This document is printed on recycled chlorine free paper.

2nd Edition-September, 2007 Printed in Japan.

00N0L168B1
(U.M-R31C-EU)